

# STARPOWER

SEMICONDUCTOR

**IGBT**

## GD35PJY120L3S

**1200V/35A PIM in one-package**

### General Description

STARPOWER IGBT Power Module provides ultra low conduction loss as well as short circuit ruggedness. They are designed for the applications such as general inverters and UPS.

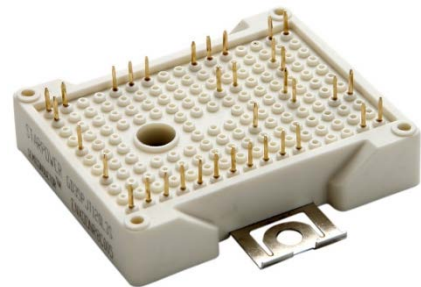

### Features

- Low  $V_{CE(sat)}$  Trench IGBT technology
- 10 $\mu$ s short circuit capability
- $V_{CE(sat)}$  with positive temperature coefficient
- Maximum junction temperature 175°C
- Low inductance case
- Fast & soft reverse recovery anti-parallel FWD
- Isolated heatsink using DBC technology

### Typical Applications

- Inverter for motor drive
- AC and DC servo drive amplifier
- Uninterruptible power supply

### Equivalent Circuit Schematic

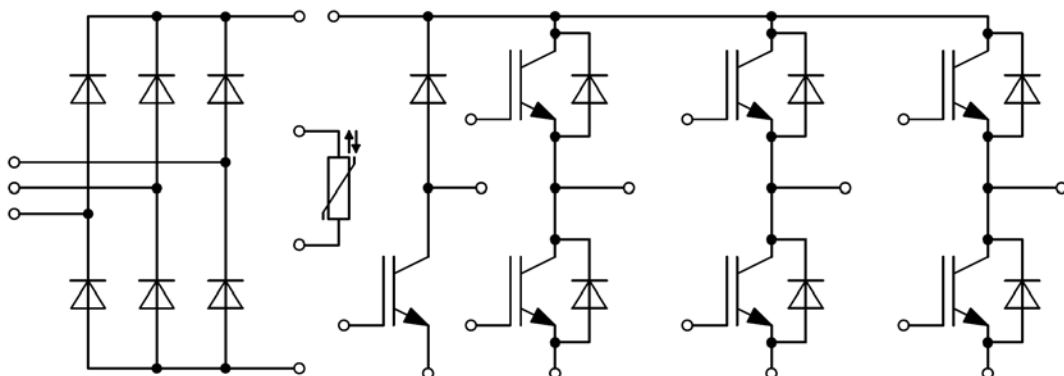

**Absolute Maximum Ratings**  $T_C=25^{\circ}\text{C}$  unless otherwise noted**IGBT-inverter**

Symbol	Description	Value	Unit
$V_{CES}$	Collector-Emitter Voltage	1200	V
$V_{GES}$	Gate-Emitter Voltage	$\pm 20$	V
$I_C$	Collector Current @ $T_C=25^{\circ}\text{C}$	70	A
	@ $T_C=100^{\circ}\text{C}$	35	A
$I_{CM}$	Pulsed Collector Current $t_p=1\text{ms}$	70	A
$P_D$	Maximum Power Dissipation @ $T_j=175^{\circ}\text{C}$	301	W

**Diode-inverter**

Symbol	Description	Value	Unit
$V_{RRM}$	Repetitive Peak Reverse Voltage	1200	V
$I_F$	Diode Continuous Forward Current	35	A
$I_{FM}$	Diode Maximum Forward Current $t_p=1\text{ms}$	70	A

**Diode-rectifier**

Symbol	Description	Value	Unit
$V_{RRM}$	Repetitive Peak Reverse Voltage	1600	V
$I_O$	Average Output Current 50Hz/60Hz,sine wave	35	A
$I_{FSM}$	Surge Forward Current $V_R=0\text{V}, t_p=10\text{ms}, T_j=45^{\circ}\text{C}$	320	A
$I^2t$	$I^2t$ -value, $V_R=0\text{V}, t_p=10\text{ms}, T_j=45^{\circ}\text{C}$	510	$\text{A}^2\text{s}$

**IGBT-brake**

Symbol	Description	Value	Unit
$V_{CES}$	Collector-Emitter Voltage	1200	V
$V_{GES}$	Gate-Emitter Voltage	$\pm 20$	V
$I_C$	Collector Current @ $T_C=25^{\circ}\text{C}$	70	A
	@ $T_C=100^{\circ}\text{C}$	35	A
$I_{CM}$	Pulsed Collector Current $t_p=1\text{ms}$	70	A
$P_D$	Maximum Power Dissipation @ $T_j=175^{\circ}\text{C}$	301	W

**Diode-brake**

Symbol	Description	Value	Unit
$V_{RRM}$	Repetitive Peak Reverse Voltage	1200	V
$I_F$	Diode Continuous Forward Current	10	A
$I_{FM}$	Diode Maximum Forward Current $t_p=1\text{ms}$	20	A

**Module**

Symbol	Description	Value	Unit
$T_{jmax}$	Maximum Junction Temperature(inverter,brake)	175	$^{\circ}\text{C}$
	Maximum Junction Temperature (rectifier)	150	$^{\circ}\text{C}$
$T_{jop}$	Operating Junction Temperature	-40 to +150	$^{\circ}\text{C}$
$T_{STG}$	Storage Temperature Range	-40 to +125	$^{\circ}\text{C}$
$V_{ISO}$	Isolation Voltage RMS, $f=50\text{Hz}, t=1\text{min}$	2500	V

**IGBT-inverter Characteristics**  $T_C=25^\circ\text{C}$  unless otherwise noted

Symbol	Parameter	Test Conditions	Min.	Typ.	Max.	Unit
$V_{CE(sat)}$	Collector to Emitter Saturation Voltage	$I_C=35\text{A}, V_{GE}=15\text{V}, T_j=25^\circ\text{C}$		1.70	2.15	V
		$I_C=35\text{A}, V_{GE}=15\text{V}, T_j=125^\circ\text{C}$		1.95		
		$I_C=35\text{A}, V_{GE}=15\text{V}, T_j=150^\circ\text{C}$		2.00		
$V_{GE(th)}$	Gate-Emitter Threshold Voltage	$I_C=0.88\text{mA}, V_{CE}=V_{GE}, T_j=25^\circ\text{C}$	5.2	6.0	6.8	V
$I_{CES}$	Collector Cut-Off Current	$V_{CE}=V_{CES}, V_{GE}=0\text{V}, T_j=25^\circ\text{C}$			1.0	mA
$I_{GES}$	Gate-Emitter Leakage Current	$V_{GE}=V_{GES}, V_{CE}=0\text{V}, T_j=25^\circ\text{C}$			400	nA
$R_{Gint}$	Internal Gate Resistance			0		$\Omega$
$Q_G$	Gate Charge	$V_{GE}=-15\dots+15\text{V}$		0.33		$\mu\text{C}$
$t_{d(on)}$	Turn-On Delay Time	$V_{CC}=600\text{V}, I_C=35\text{A}, R_G=13\Omega, V_{GE}=\pm 15\text{V}, T_j=25^\circ\text{C}$		156		ns
$t_r$	Rise Time			28		ns
$t_{d(off)}$	Turn-Off Delay Time			215		ns
$t_f$	Fall Time			323		ns
$E_{on}$	Turn-On Switching Loss			1.94		mJ
$E_{off}$	Turn-Off Switching Loss			2.55		mJ
$t_{d(on)}$	Turn-On Delay Time	$V_{CC}=600\text{V}, I_C=35\text{A}, R_G=13\Omega, V_{GE}=\pm 15\text{V}, T_j=125^\circ\text{C}$		156		ns
$t_r$	Rise Time			30		ns
$t_{d(off)}$	Turn-Off Delay Time			229		ns
$t_f$	Fall Time			507		ns
$E_{on}$	Turn-On Switching Loss			2.38		mJ
$E_{off}$	Turn-Off Switching Loss			3.83		mJ
$t_{d(on)}$	Turn-On Delay Time	$V_{CC}=600\text{V}, I_C=35\text{A}, R_G=13\Omega, V_{GE}=\pm 15\text{V}, T_j=150^\circ\text{C}$		153		ns
$t_r$	Rise Time			32		ns
$t_{d(off)}$	Turn-Off Delay Time			234		ns
$t_f$	Fall Time			522		ns
$E_{on}$	Turn-On Switching Loss			2.60		mJ
$E_{off}$	Turn-Off Switching Loss			4.02		mJ
$I_{SC}$	SC Data	$t_p \leq 10\mu\text{s}, V_{GE}=15\text{V}, T_j=150^\circ\text{C}, V_{CC}=900\text{V}, V_{CEM} \leq 1200\text{V}$		140		A

**Diode-inverter Characteristics**  $T_C=25^\circ\text{C}$  unless otherwise noted

Symbol	Parameter	Test Conditions	Min.	Typ.	Max.	Unit
$V_F$	Diode Forward Voltage	$I_F=35\text{A}, V_{GE}=0\text{V}, T_j=25^\circ\text{C}$		2.00	2.45	V
		$I_F=35\text{A}, V_{GE}=0\text{V}, T_j=125^\circ\text{C}$		1.90		
		$I_F=35\text{A}, V_{GE}=0\text{V}, T_j=150^\circ\text{C}$		1.88		
$Q_r$	Recovered Charge	$V_R=600\text{V}, I_F=35\text{A},$ $-di/dt=1050\text{A}/\mu\text{s}, V_{GE}=-15\text{V}$ $T_j=25^\circ\text{C}$		1.9		$\mu\text{C}$
$I_{RM}$	Peak Reverse Recovery Current			43		A
$E_{rec}$	Reverse Recovery Energy			1.01		mJ
$Q_r$	Recovered Charge	$V_R=600\text{V}, I_F=35\text{A},$ $-di/dt=1050\text{A}/\mu\text{s}, V_{GE}=-15\text{V}$ $T_j=125^\circ\text{C}$		3.1		$\mu\text{C}$
$I_{RM}$	Peak Reverse Recovery Current			51		A
$E_{rec}$	Reverse Recovery Energy			2.37		mJ
$Q_r$	Recovered Charge	$V_R=600\text{V}, I_F=35\text{A},$ $-di/dt=1050\text{A}/\mu\text{s}, V_{GE}=-15\text{V}$ $T_j=150^\circ\text{C}$		3.5		$\mu\text{C}$
$I_{RM}$	Peak Reverse Recovery Current			53		A
$E_{rec}$	Reverse Recovery Energy			2.77		mJ

**Diode-rectifier Characteristics**  $T_C=25^\circ\text{C}$  unless otherwise noted

Symbol	Parameter	Test Conditions	Min.	Typ.	Max.	Unit
$V_F$	Diode Forward Voltage	$I_F=35\text{A}, T_j=150^\circ\text{C}$		1.12		V
$I_R$	Reverse Current	$T_j=150^\circ\text{C}, V_R=1600\text{V}$			2.0	mA

**IGBT-brake Characteristics**  $T_C=25^\circ\text{C}$  unless otherwise noted

Symbol	Parameter	Test Conditions	Min.	Typ.	Max.	Unit
$V_{CE(sat)}$	Collector to Emitter Saturation Voltage	$I_C=35\text{A}, V_{GE}=15\text{V}, T_j=25^\circ\text{C}$		1.70	2.15	V
		$I_C=35\text{A}, V_{GE}=15\text{V}, T_j=125^\circ\text{C}$		1.95		
		$I_C=35\text{A}, V_{GE}=15\text{V}, T_j=150^\circ\text{C}$		2.00		
$V_{GE(th)}$	Gate-Emitter Threshold Voltage	$I_C=0.88\text{mA}, V_{CE}=V_{GE}, T_j=25^\circ\text{C}$	5.2	6.0	6.8	V
$I_{CES}$	Collector Cut-Off Current	$V_{CE}=V_{CES}, V_{GE}=0\text{V}, T_j=25^\circ\text{C}$			1.0	mA
$I_{GES}$	Gate-Emitter Leakage Current	$V_{GE}=V_{GES}, V_{CE}=0\text{V}, T_j=25^\circ\text{C}$			400	nA
$R_{Gint}$	Internal Gate Resistance			0		$\Omega$
$Q_G$	Gate Charge	$V_{GE}=-15\dots+15\text{V}$		0.33		$\mu\text{C}$
$t_{d(on)}$	Turn-On Delay Time	$V_{CC}=600\text{V}, I_C=35\text{A}, R_G=13\Omega, V_{GE}=\pm 15\text{V}, T_j=25^\circ\text{C}$		156		ns
$t_r$	Rise Time			28		ns
$t_{d(off)}$	Turn-Off Delay Time			215		ns
$t_f$	Fall Time			323		ns
$E_{on}$	Turn-On Switching Loss			1.94		mJ
$E_{off}$	Turn-Off Switching Loss			2.55		mJ
$t_{d(on)}$	Turn-On Delay Time	$V_{CC}=600\text{V}, I_C=35\text{A}, R_G=13\Omega, V_{GE}=\pm 15\text{V}, T_j=125^\circ\text{C}$		156		ns
$t_r$	Rise Time			30		ns
$t_{d(off)}$	Turn-Off Delay Time			229		ns
$t_f$	Fall Time			507		ns
$E_{on}$	Turn-On Switching Loss			2.38		mJ
$E_{off}$	Turn-Off Switching Loss			3.83		mJ
$t_{d(on)}$	Turn-On Delay Time	$V_{CC}=600\text{V}, I_C=35\text{A}, R_G=13\Omega, V_{GE}=\pm 15\text{V}, T_j=150^\circ\text{C}$		153		ns
$t_r$	Rise Time			32		ns
$t_{d(off)}$	Turn-Off Delay Time			234		ns
$t_f$	Fall Time			522		ns
$E_{on}$	Turn-On Switching Loss			2.60		mJ
$E_{off}$	Turn-Off Switching Loss			4.02		mJ
$I_{SC}$	SC Data	$t_p \leq 10\mu\text{s}, V_{GE}=15\text{V}, T_j=150^\circ\text{C}, V_{CC}=900\text{V}, V_{CEM} \leq 1200\text{V}$		140		A

**Diode-brake Characteristics**  $T_C=25^\circ\text{C}$  unless otherwise noted

Symbol	Parameter	Test Conditions	Min.	Typ.	Max.	Unit
$V_F$	Diode Forward Voltage	$I_F=10\text{A}, V_{GE}=0\text{V}, T_j=25^\circ\text{C}$		1.85	2.30	V
		$I_F=10\text{A}, V_{GE}=0\text{V}, T_j=125^\circ\text{C}$		2.05		
		$I_F=10\text{A}, V_{GE}=0\text{V}, T_j=150^\circ\text{C}$		2.10		
$Q_r$	Recovered Charge	$V_R=600\text{V}, I_F=10\text{A},$ $-di/dt=500\text{A}/\mu\text{s}, V_{GE}=-15\text{V}$ $T_j=25^\circ\text{C}$		0.86		$\mu\text{C}$
$I_{RM}$	Peak Reverse Recovery Current			8		A
$E_{rec}$	Reverse Recovery Energy			0.23		mJ
$Q_r$	Recovered Charge	$V_R=600\text{V}, I_F=10\text{A},$ $-di/dt=500\text{A}/\mu\text{s}, V_{GE}=-15\text{V}$ $T_j=125^\circ\text{C}$		1.6		$\mu\text{C}$
$I_{RM}$	Peak Reverse Recovery Current			10		A
$E_{rec}$	Reverse Recovery Energy			0.49		mJ
$Q_r$	Recovered Charge	$V_R=600\text{V}, I_F=10\text{A},$ $-di/dt=500\text{A}/\mu\text{s}, V_{GE}=-15\text{V}$ $T_j=150^\circ\text{C}$		1.8		$\mu\text{C}$
$I_{RM}$	Peak Reverse Recovery Current			11		A
$E_{rec}$	Reverse Recovery Energy			0.56		mJ

**NTC Characteristics**  $T_C=25^\circ\text{C}$  unless otherwise noted

Symbol	Parameter	Test Conditions	Min.	Typ.	Max.	Unit
$R_{25}$	Rated Resistance			5.0		$\text{k}\Omega$
$\Delta R/R$	Deviation of $R_{100}$	$T_C=100^\circ\text{C}, R_{100}=493.3\Omega$	-5		5	%
$P_{25}$	Power Dissipation				20.0	mW
$B_{25/50}$	B-value	$R_2=R_{25}\exp[B_{25/50}(1/T_2-1/(298.15\text{K}))]$		3375		K
$B_{25/80}$	B-value	$R_2=R_{25}\exp[B_{25/80}(1/T_2-1/(298.15\text{K}))]$		3411		K
$B_{25/100}$	B-value	$R_2=R_{25}\exp[B_{25/100}(1/T_2-1/(298.15\text{K}))]$		3433		K

**Module Characteristics**  $T_c=25^\circ\text{C}$  unless otherwise noted

Symbol	Parameter	Min.	Typ.	Max.	Unit
$L_{CE}$	Stray Inductance		30		nH
$R_{CC'+EE'}$ $R_{AA'+CC'}$	Module Lead Resistance, Terminal to Chip		5.00 6.00		m $\Omega$
$R_{thJC}$	Junction-to-Case (per IGBT-inverter)		0.453	0.498	K/W
	Junction-to-Case (per Diode-inverter)		0.786	0.865	
	Junction-to-Case (per Diode-rectifier)		0.856	0.942	
	Junction-to-Case (per IGBT-brake)		0.453	0.498	
	Junction-to-Case (per Diode-brake)		1.541	1.695	
$R_{thCH}$	Case-to-Heatsink (per IGBT-inverter)		0.515		K/W
	Case-to-Heatsink (per Diode-inverter)		0.895		
	Case-to-Heatsink (per Diode-rectifier)		0.974		
	Case-to-Heatsink (per IGBT-brake)		0.515		
	Case-to-Heatsink (per Diode-brake)		1.753		
	Case-to-Heatsink (per Module)		0.037		
F	Mounting Force Per Clamp	40		80	N
G	Weight of Module		39		g

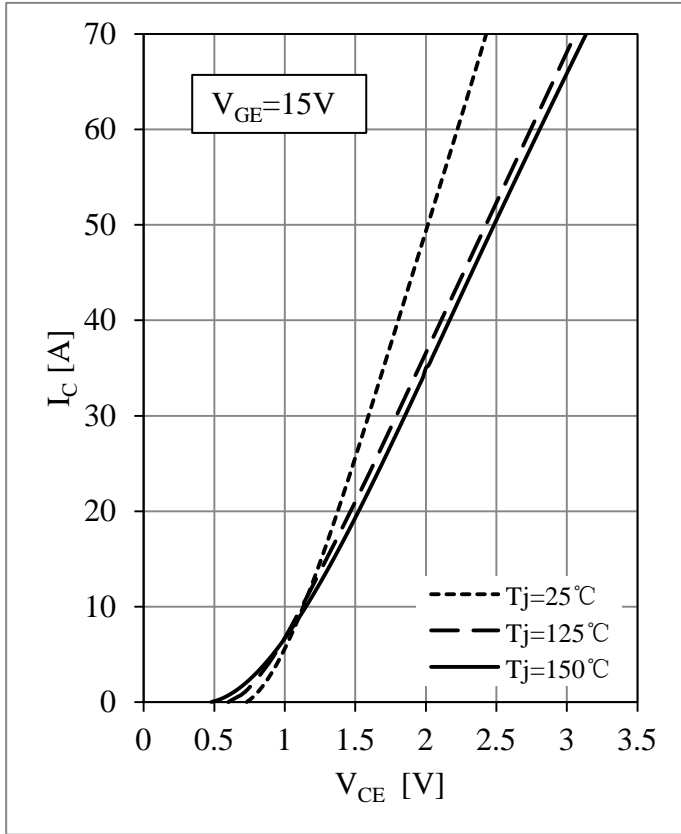

Fig 1. IGBT-inverter Output Characteristics

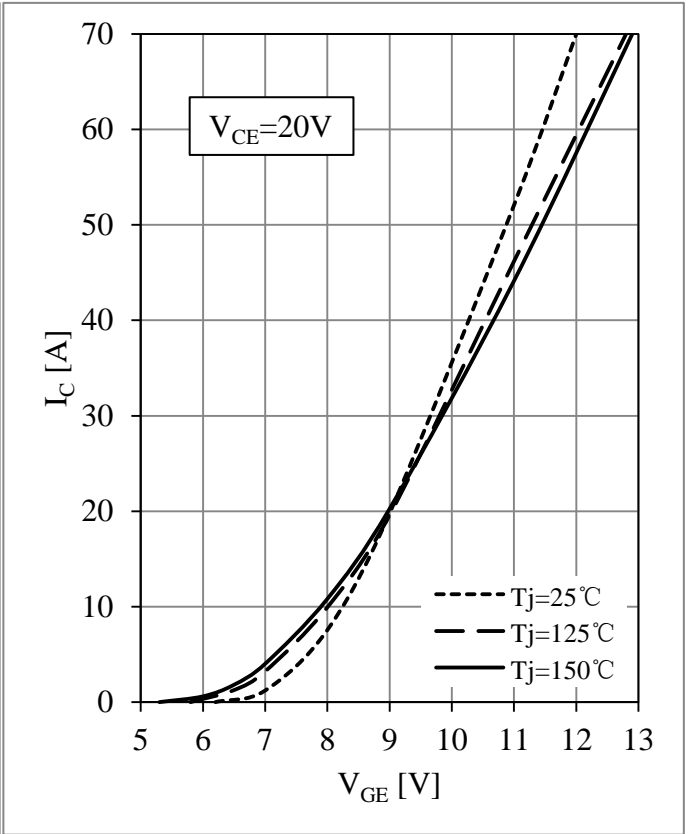

Fig 2. IGBT-inverter Transfer Characteristics

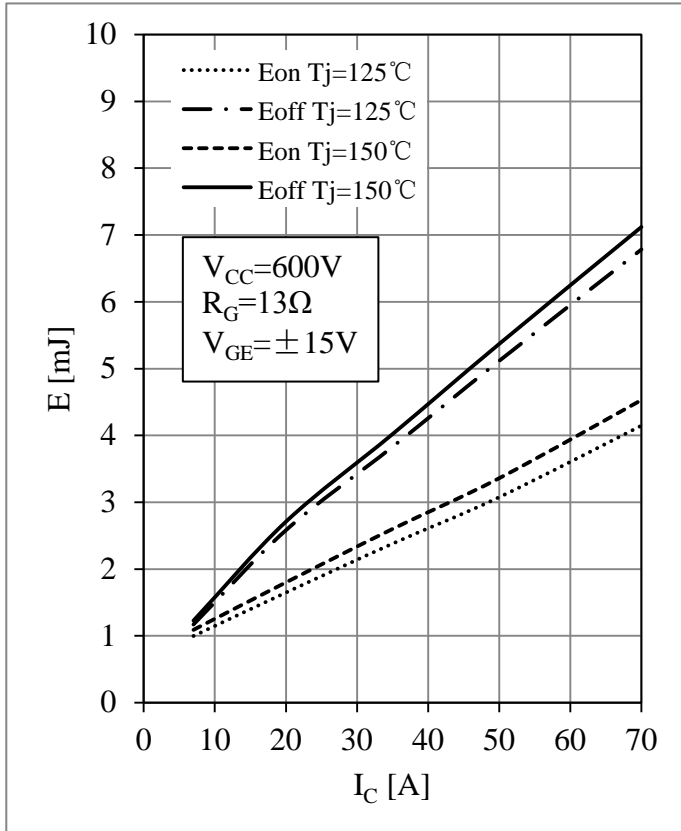

Fig 3. IGBT-inverter Switching Loss vs.  $I_C$

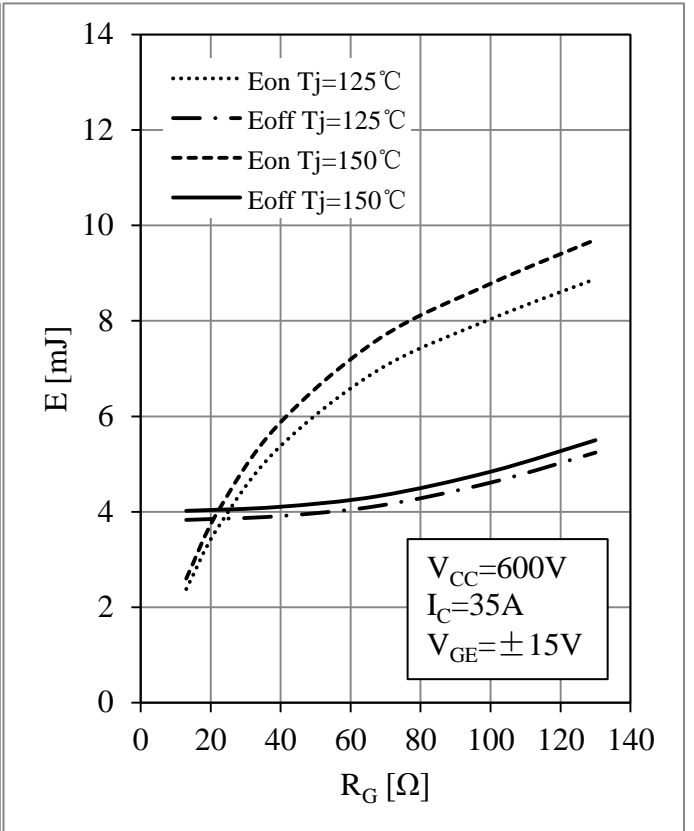

Fig 4. IGBT-inverter Switching Loss vs.  $R_G$



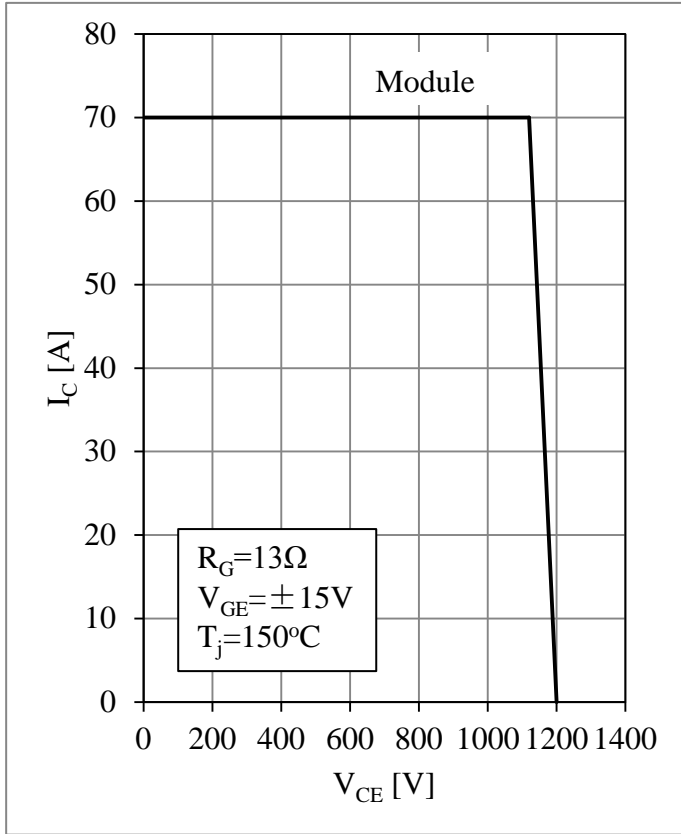

Fig 5. IGBT-inverter RBSOA

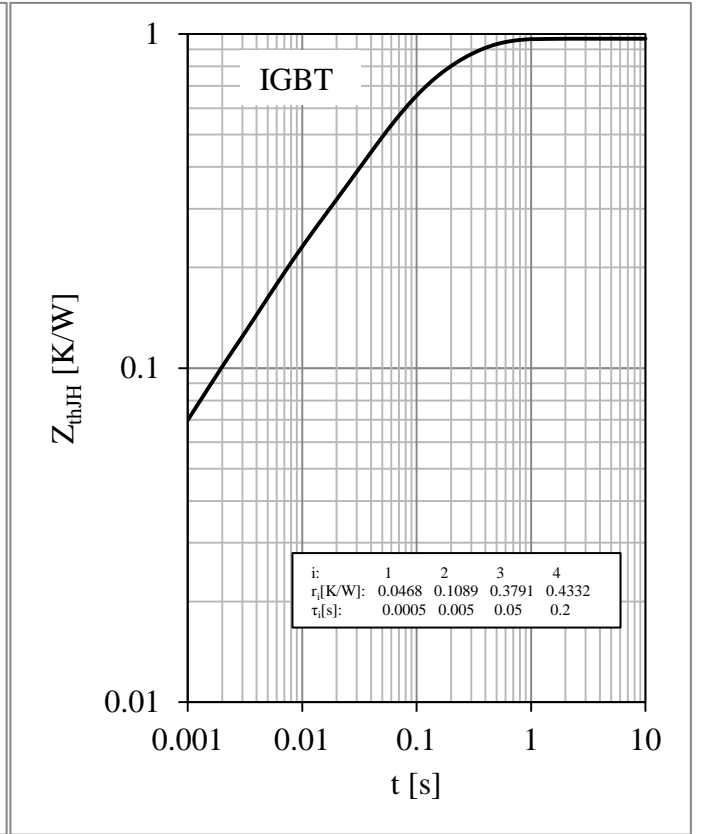

Fig 6. IGBT-inverter Transient Thermal Impedance

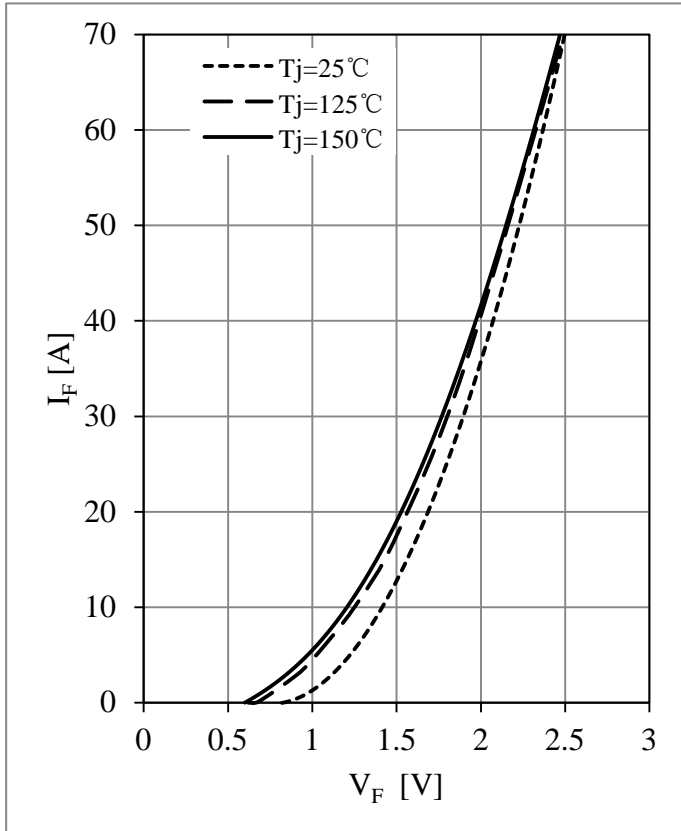

Fig 7. Diode-inverter Forward Characteristics

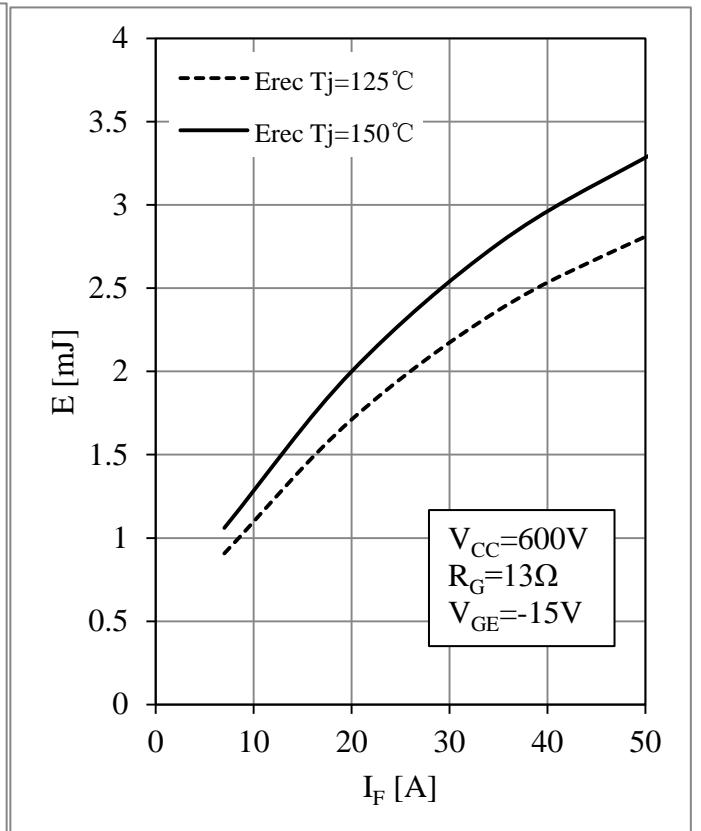

Fig 8. Diode-inverter Switching Loss vs.  $I_F$

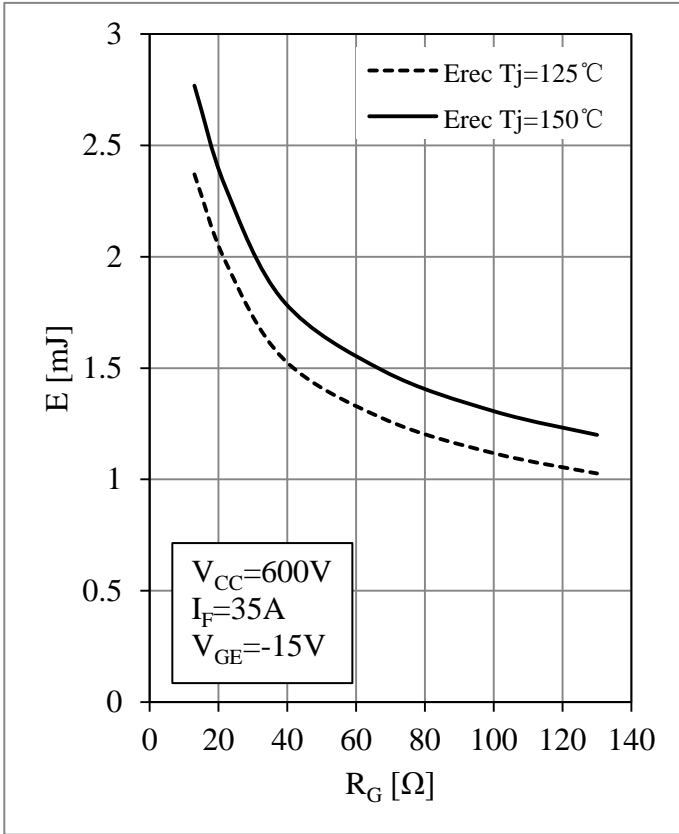

Fig 9. Diode-inverter Switching Loss vs.  $R_G$

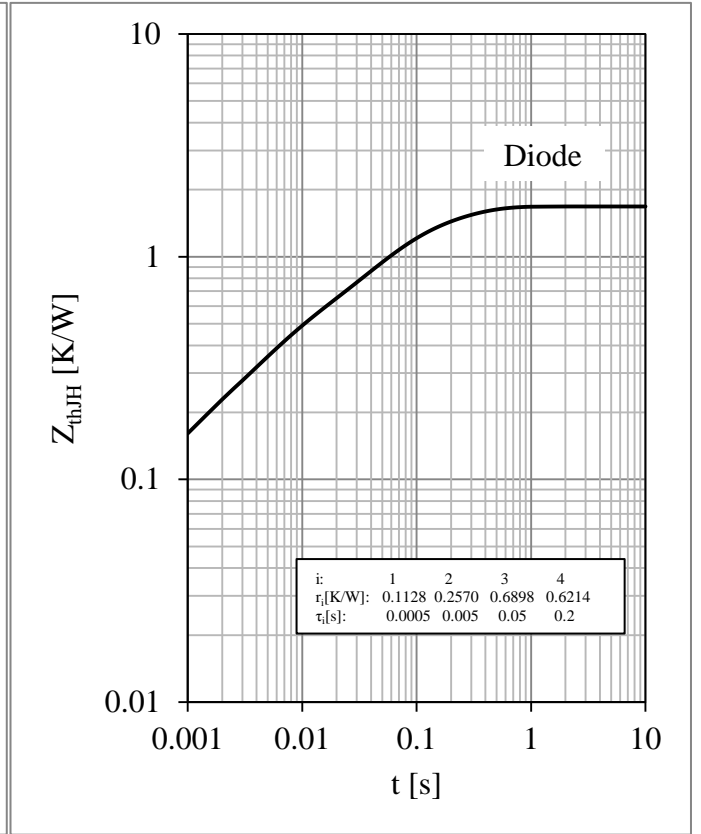

Fig 10. Diode-inverter Transient Thermal Impedance

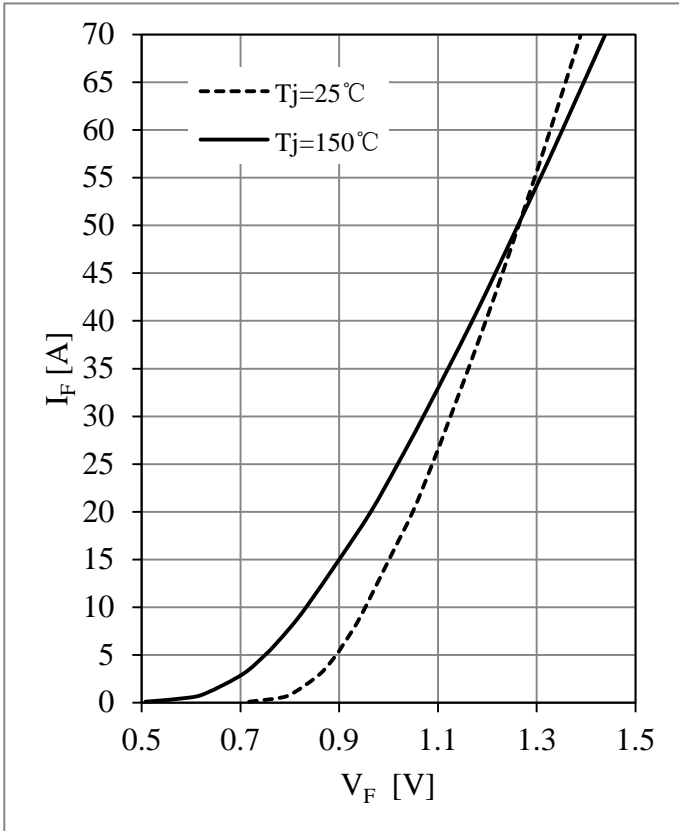

Fig 11. Diode-rectifier Forward Characteristics

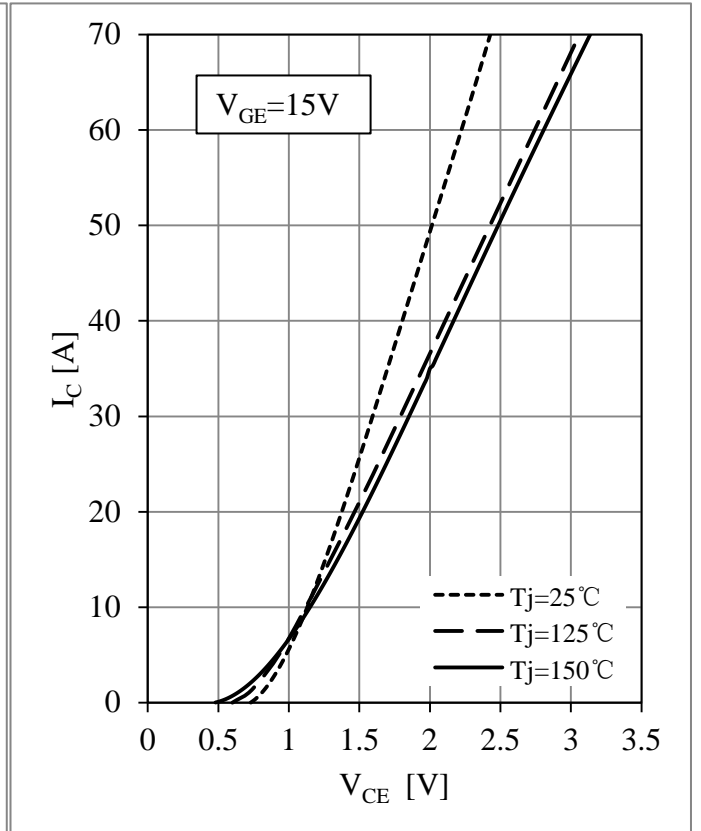

Fig 12. IGBT-brake-chopper Output Characteristics

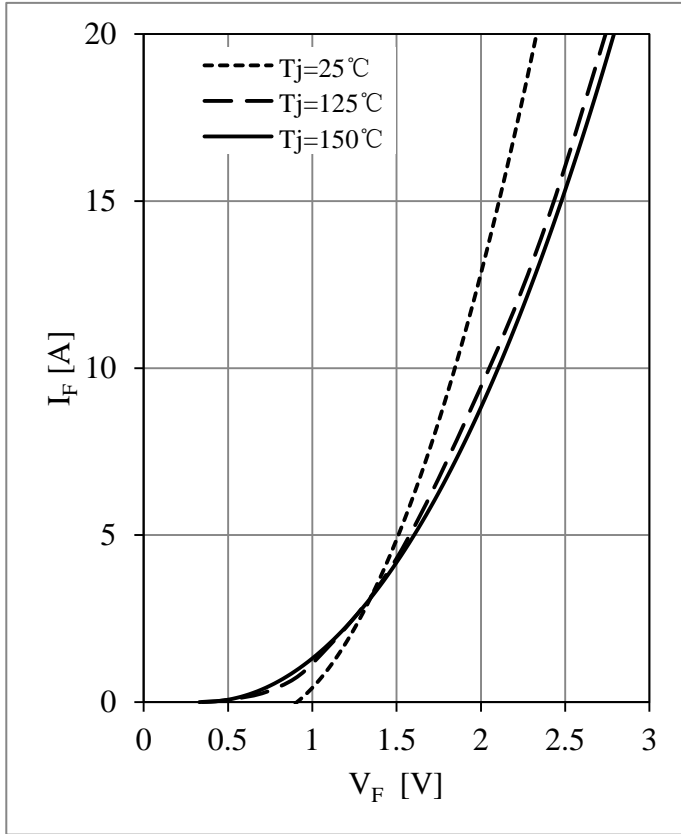

Fig 13. Diode-brake-chopper Forward Characteristics

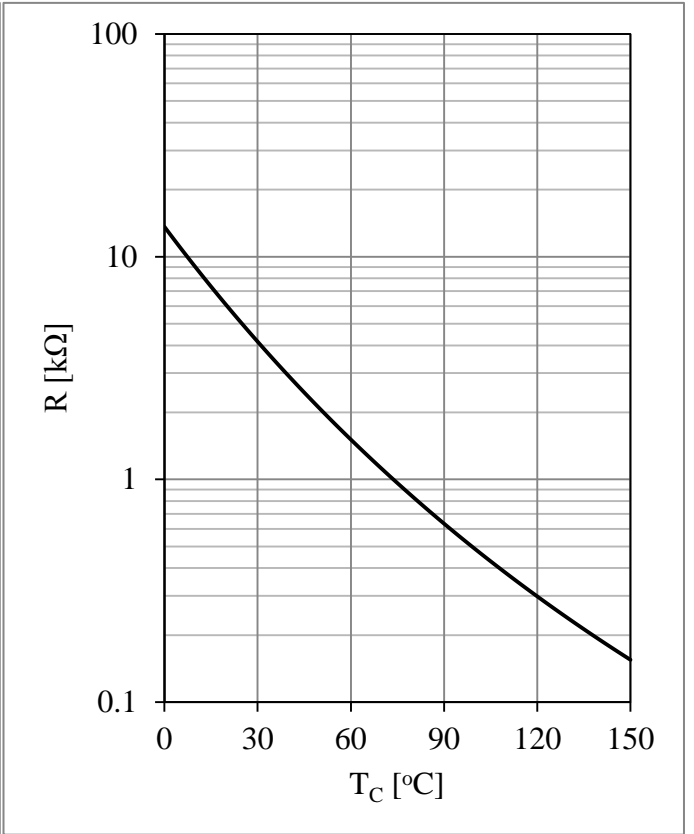
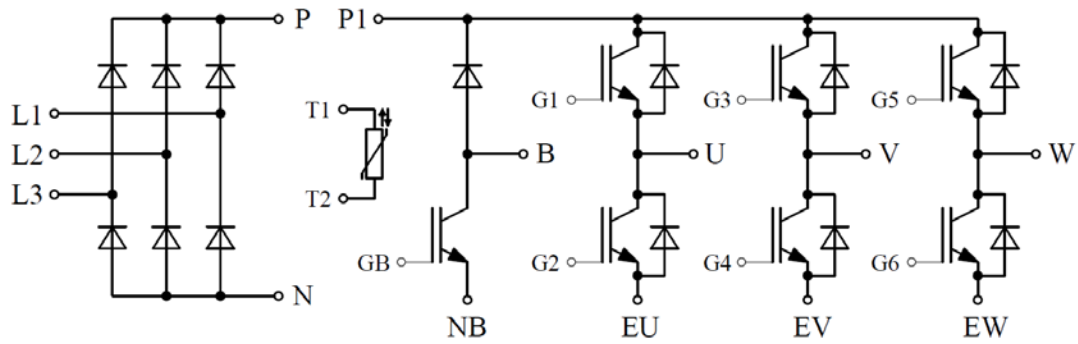

Fig 14. NTC Temperature Characteristic

**Circuit Schematic**



**Package Dimensions**

Dimensions in Millimeters

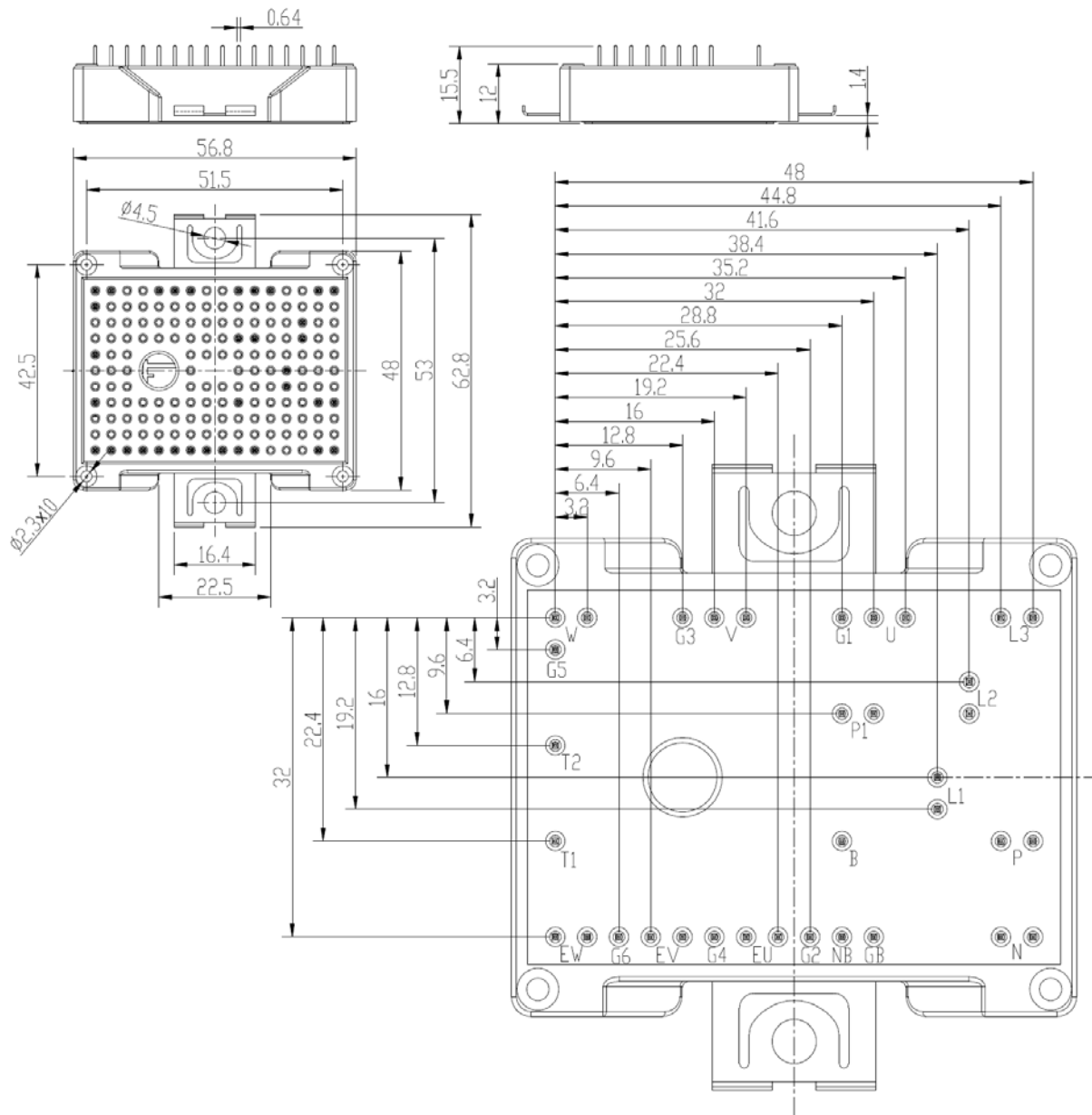

## Terms and Conditions of Usage

The data contained in this product datasheet is exclusively intended for technically trained staff. you and your technical departments will have to evaluate the suitability of the product for the intended application and the completeness of the product data with respect to such application.

This product data sheet is describing the characteristics of this product for which a warranty is granted. Any such warranty is granted exclusively pursuant the terms and conditions of the supply agreement. There will be no guarantee of any kind for the product and its characteristics.

Should you require product information in excess of the data given in this product data sheet or which concerns the specific application of our product, please contact the sales office, which is responsible for you (see [www.powersemi.cc](http://www.powersemi.cc)), For those that are specifically interested we may provide application notes.

Due to technical requirements our product may contain dangerous substances. For information on the types in question please contact the sales office, which is responsible for you.

Should you intend to use the Product in aviation applications, in health or live endangering or life support applications, please notify.

If and to the extent necessary, please forward equivalent notices to your customers.  
Changes of this product data sheet are reserved.