

SILICON CONTROLLED RECTIFIERS

High Power Thyristor Hockey Puk Version A-PUK Series 500PA

Types : 500PA 20 to 500PA 120

FEATURES

- ❖ Center amplifying gate.
- ❖ International standard case TO-200AB (A-PUK)

TYPICAL APPLICATIONS

- ❖ DC motor control (e.g. for machine tools).
- ❖ Controlled rectifiers (e.g. for battery charging, UPS).
- ❖ AC controllers (e.g. for temperature control, lights control).



MAJOR RATINGS & CHARACTERISTICS

Parameters	500PA	Units
$I_{T(AV)}$	500	A
@ T_{hs}	55	°C
$I_{T(RMS)}$	785	A
@ T_{hs}	55	°C
I_{TSM}	7850	A
@ 50 Hz		
I^2t	308	KA ² s
@ 50 Hz		
V_{DRM} / V_{RRM}	200 to 1200	V
t_q	100	μs
typical		
T_j	-40 to 125	°C

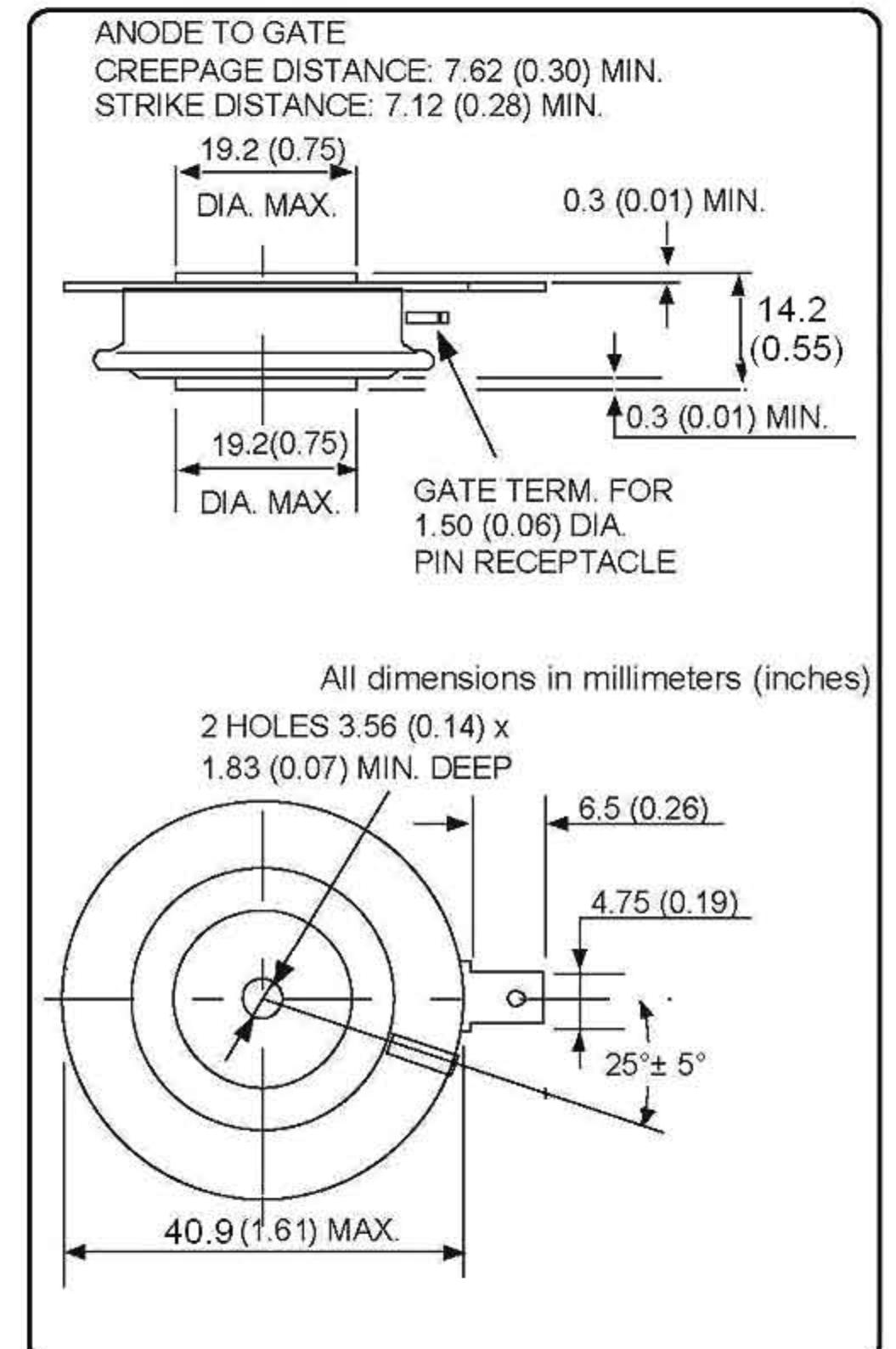

SILICON CONTROLLED RECTIFIERS

500PA

ELECTRICAL SPECIFICATION VOLTAGE RATINGS

Type Number	Voltage Code	V_{RRM} / V_{DRM} max. repetitive peak and off-state voltage V	V_{RSM} max. non-repetitive peak voltage V	I_{DRM} / I_{RRM} max. @ 125°C mA
500PA	20	200	300	30
	40	400	500	
	60	600	700	
	80	800	900	
	100	1000	1100	
	120	1200	1300	

ON-STATE CONDUCTION

Parameter	500PA	Units	Conditions
$I_{T(AV)}$	Max. average on-state current @ heat sink temperature	500	180° conduction, half sine wave double side cooled
		55	
$I_{T(RMS)}$	Max. RMS on-state current	785	@55°C heat sink temperature (double side cooled)
I_{TSM}	Max. peak, one cycle non-repetitive surge current	7850	t = 10ms Sinusoidal half wave, Initial $T_J = T_J$ max.
I^2t	Maximum I^2t for fusing	308	t = 10ms
I^2t	Maximum I^2t for fusing	3080	t = 0.1 to 10ms.
$V_{T(TO)}$	Threshold voltage	0.84	$T_J = T_J$ max.
r_t	On state slope resistance	0.74	$T_J = T_J$ max.
V_{TM}	Max. on state voltage	1.36	$I_{pk} = 1050A$, $T_J = 125^\circ C$, $t_p = 10ms$ sine pulse
I_H	Maximum holding current	300	$T_J = 25^\circ C$, anode supply 12V resistive load
I_L	Latching current	600	

SWITCHING

Parameter	500PA	Units	Conditions
di/dt	Max. non-repetitive rate of rise of turned-on current	100	Gate drive 20V, 20Ω, $t_r \leq 1 \mu s$ $T_J = 125^\circ C$, anode voltage $\leq 80\% V_{DRM}$
t_d	Typical delay time	1.0	Gate current 1A, $di_g/dt = 1A/\mu s$ $V_d = 0.67\% V_{DRM}$, $T_J = 25^\circ C$
t_q	Typical turn-off time	100	$I_{TM} = 300A$, $T_J = 125^\circ C$, $di/dt = 20A/\mu s$, $V_R = 50V$ $dv/dt = 20V/\mu s$, Gate 0V 100Ω, $t_p = 500\mu s$

SILICON CONTROLLED RECTIFIERS

500PA

BLOCKING

	Parameter	500PA	Units	Conditions
dv/dt	Maximum critical rate of rise of off-state voltage	500	V/ μ s	$T_J = 125^\circ\text{C}$, linear to 80% rated V_{DRM}
I_{RRM} I_{DRM}	Max. peak reverse and off-state leakage current	30	mA	$T_J = 125^\circ\text{C}$, rated $V_{\text{DRM}}/V_{\text{RRM}}$ applied

* Higher dv/dt is available on request

TRIGGERING

	Parameter	500PA		Units	Conditions
P_{GM}	Maximum peak gate power	10.0		W	$T_J = 125^\circ\text{C}$, $t_p \leq 5\text{ms}$
$P_{\text{G(AV)}}$	Maximum average gate power	2.0			$T_J = 125^\circ\text{C}$, $f = 50\text{Hz}$, $d\% = 50$
I_{GM}	Max. peak positive gate current	3.0		A	$T_J = 125^\circ\text{C}$, $t_p \leq 5\text{ms}$
$+V_{\text{GM}}$	Max. peak positive gate voltage	20		V	$T_J = 125^\circ\text{C}$, $t_p \leq 5\text{ms}$
$-V_{\text{GM}}$	Max. peak negative gate voltage	5.0			
I_{GT}	DC gate current required to trigger	TYP.	MAX.	mA	$T_J = 25^\circ\text{C}$ Max. required gate trigger/current / voltage are the lowest value which will trigger all units 12V anode-to-cathode applied.
		90	150		
V_{GT}	DC gate voltage required to trigger	1.8	3.0	V	$T_J = 25^\circ\text{C}$
I_{GD}	DC gate current not to trigger	10		mA	$T_J = 125^\circ\text{C}$ Max. gate current / voltage not to trigger is the max. value which will not trigger any unit with rated V_{DRM} anode-to-cathode applied.
V_{GD}	DC gate voltage not to trigger	0.3		V	

THERMAL AND MECHANICAL SPECIFICATION

	Parameter	500PA	Units	Conditions
T_J	Max. operating temperature range	-40 to 125	$^\circ\text{C}$	
T_{stg}	Max. storage temperature range	-40 to 150		
$R_{\text{thJ-hs}}$	Max. thermal resistance, junction to heat sink	0.08	K/W	DC operation double side cooled
F	Mounting force, $\pm 10\%$	4900 (500)	N (kg)	
wt	Approximate weight	50	g	
	Case style	To - 200AB (A-PUK)		See outline

SILICON CONTROLLED RECTIFIERS

500 PA

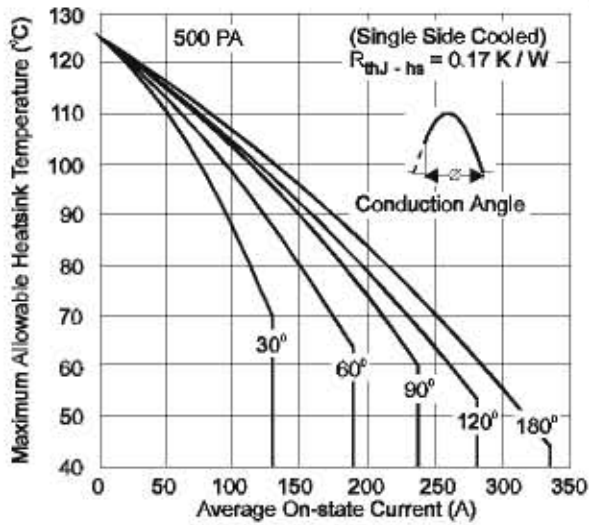

Fig. 1 - Current Ratings Characteristics

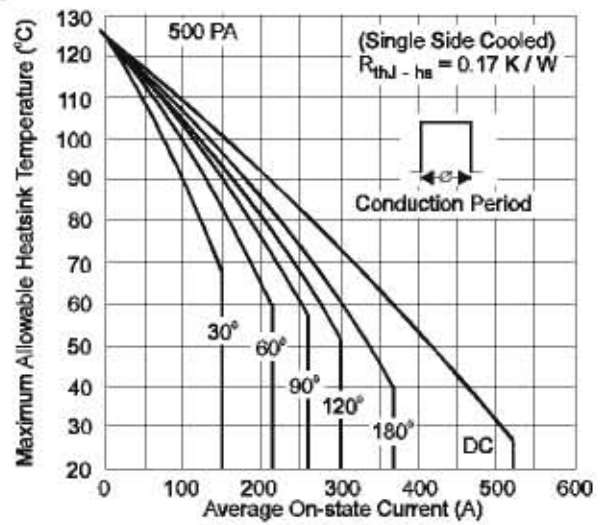

Fig. 2 - Current Ratings Characteristics

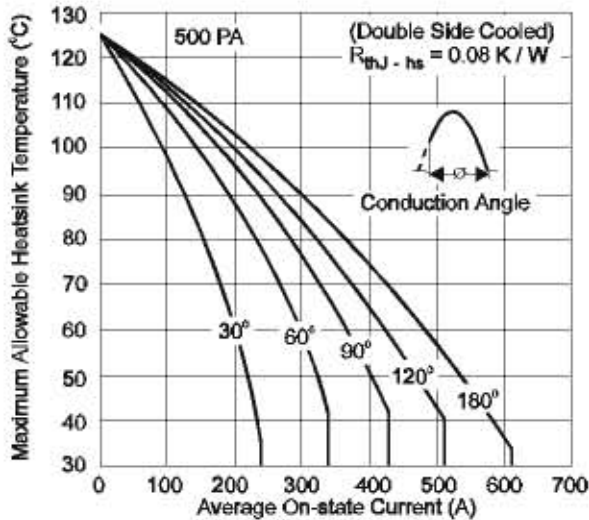

Fig. 3 - Current Ratings Characteristics

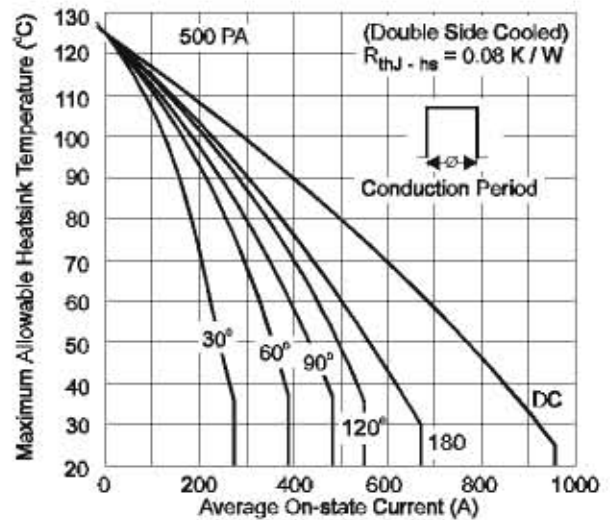

Fig. 4 - Current Ratings Characteristics

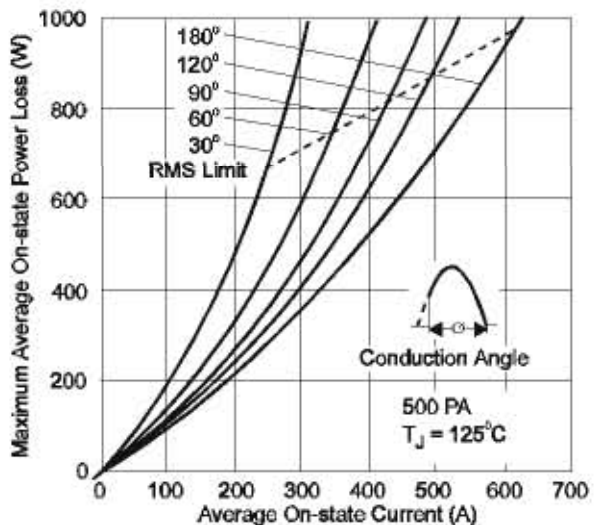

Fig. 5 - On-state Power Loss Characteristics

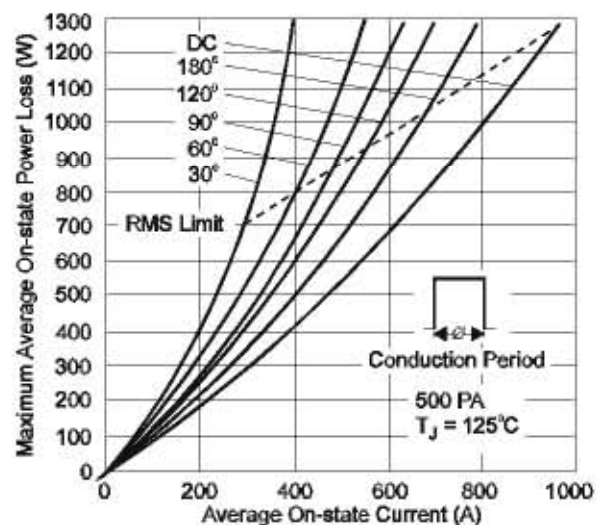

Fig. 6 - On-state Power Loss Characteristics

SILICON CONTROLLED RECTIFIERS

500 PA

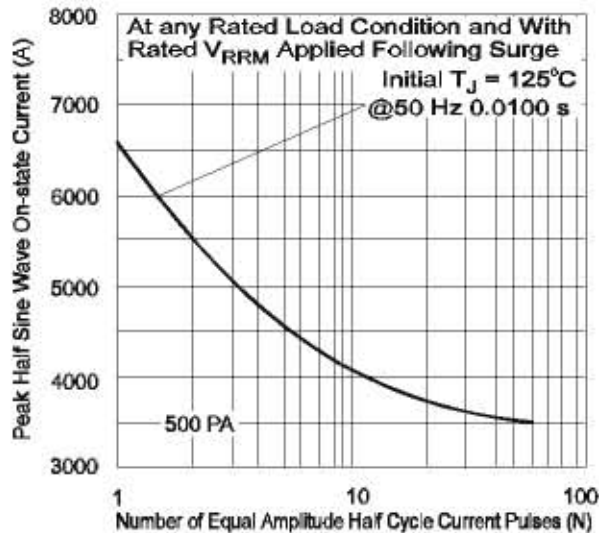

Fig. 7 - Maximum Non-Repetitive Surge Current

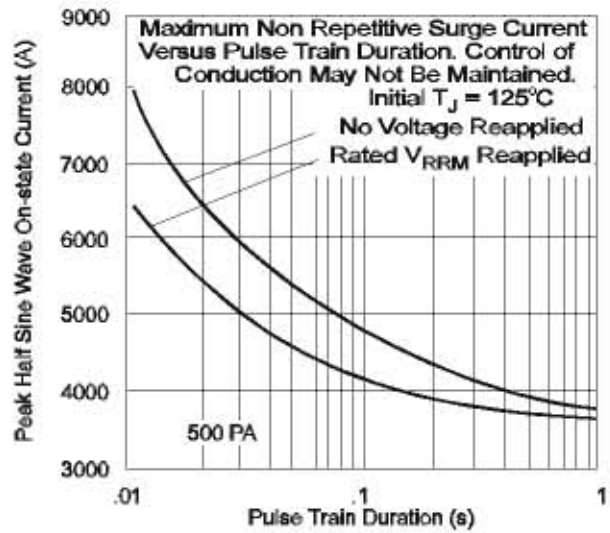

Fig. 8 - Maximum Non-Repetitive Surge Current

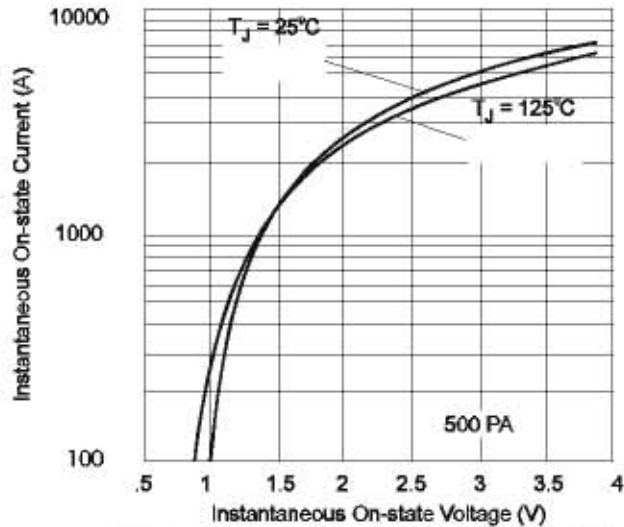

Fig. 9 - On-state Voltage Drop Characteristics

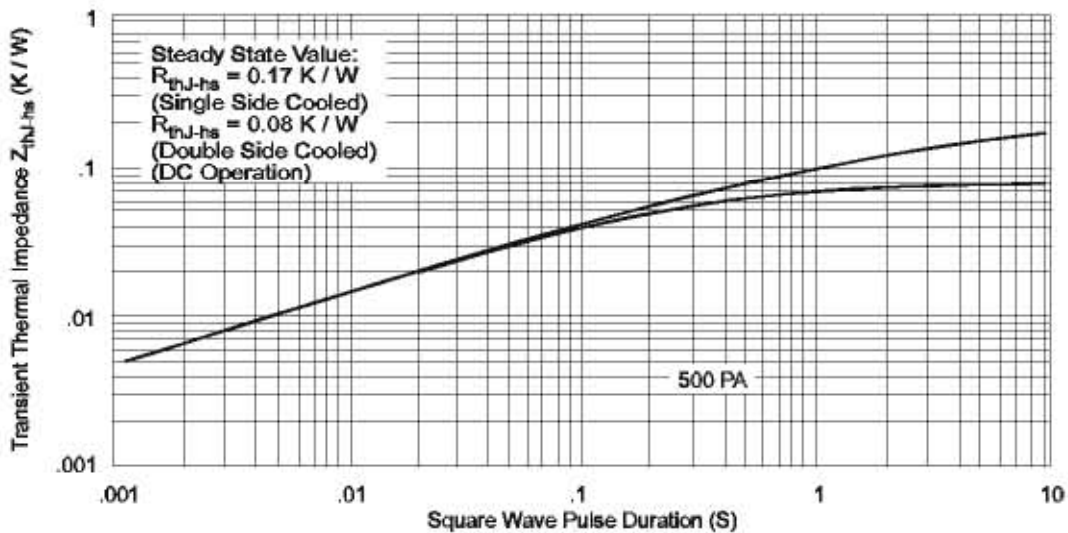

Fig. 10 - Thermal Impedance Z_{thJ-hs} Characteristics

SILICON CONTROLLED RECTIFIERS

500 PA

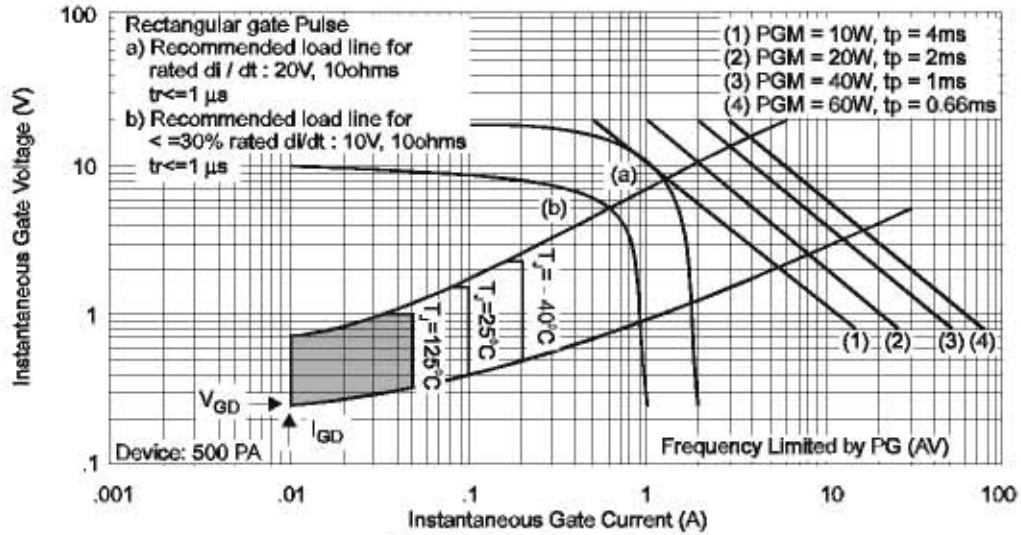

Fig.11 - Gate Characteristics

Last Update : Mar. 2006