



Ruttonsha International Rectifier Ltd.

SILICON CONTROLLED RECTIFIERS

255RK SERIES

Power Silicon Controlled Rectifiers

Types : 255RK20 TO 255RK160

FEATURES

- ❖ Centre amplifying gate.
- ❖ International standard case TO-209AB (TO-118).
- ❖ Threaded studs UNF 3/4 - 16UNF2A.
- ❖ Compression Bonded Encapsulation for heavy duty operations such as severe thermal cycling.

TYPICAL APPLICATIONS

- ❖ DC motor control (e.g. for machine tools).
- ❖ Controlled rectifiers (e.g. for battery charging, UPS).
- ❖ AC controllers (e.g. temperature control, lights control).

MAJOR RATINGS & CHARACTERISTICS

Parameters	255RK	Units
$I_{T(AV)}$	250	A
@ T_c	75	°C
$I_{T(RMS)}$	400	A
I_{TSM} @ 50 Hz	5570	A
I^2t @ 50 Hz	155	KA ² s
V_{DRM} / V_{RRM}	200 to 1600	V
t_q typical	100	μs
T_J	-40 to 125	°C

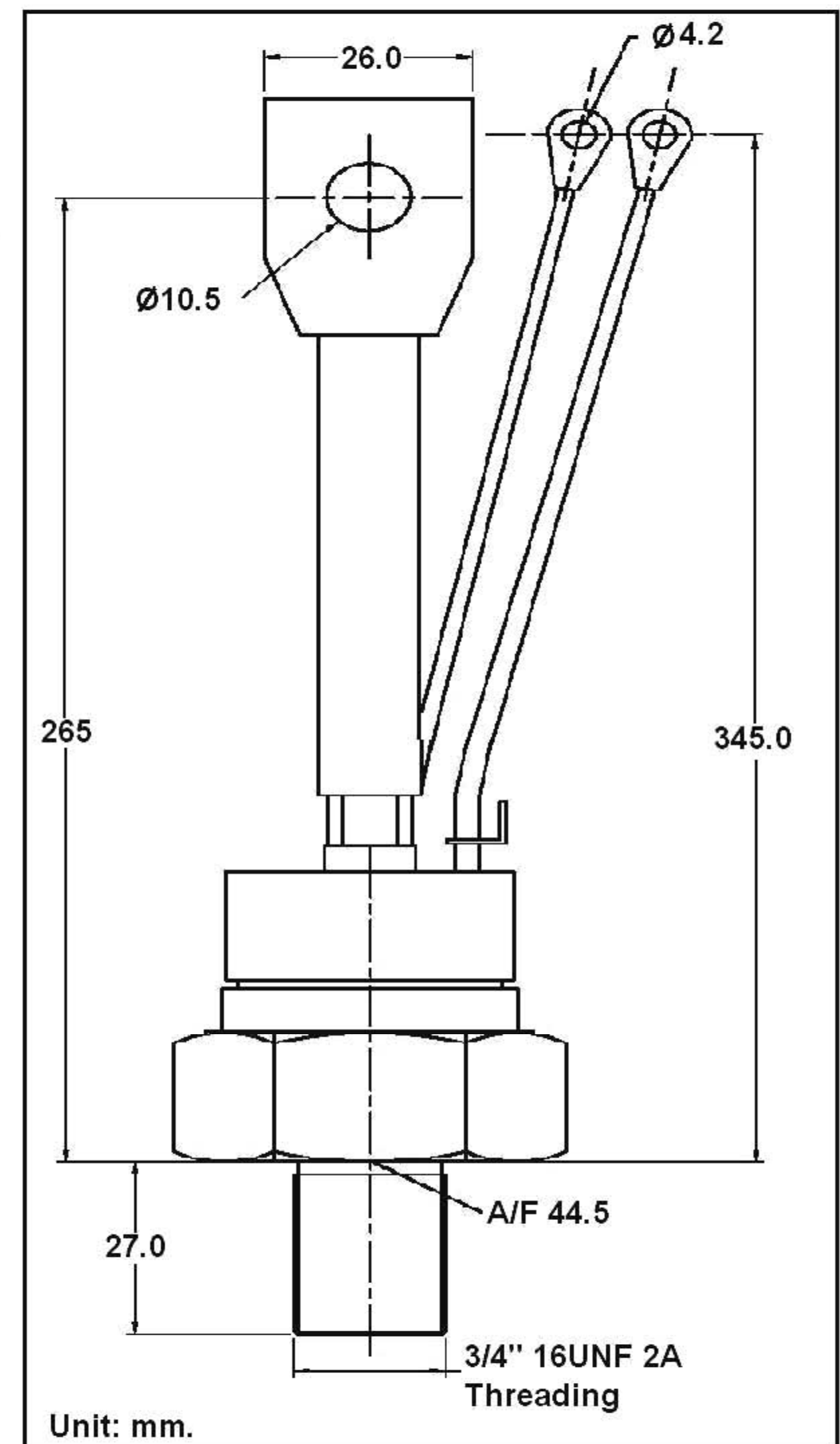

SILICON CONTROLLED RECTIFIERS

255RK SERIES

ELECTRICAL SPECIFICATION VOLTAGE RATINGS

Type Number	Voltage Code	V_{RRM} / V_{DRM} max. repetitive peak and off-state voltage V	V_{RSM} max. non-repetitive peak voltage V	I_{DRM} / I_{RRM} max. @ 125°C mA
255RK	20	200	300	50
	40	400	500	
	60	600	700	
	80	800	900	
	100	1000	1100	
	120	1200	1300	
	140	1400	1500	
	160	1600	1700	

ON-STATE CONDUCTION

Parameter	255RK	Units	Conditions
$I_{T(AV)}$ Max. average on-state current @ case temperature	250	A	180° conduction, half sine wave
	75	°C	
$I_{T(RMS)}$ Max. RMS on-state current			DC @ 75 Deg.C case Temp.
I_{TSM} Max. peak one cycle non-repetitive surge current	5570	A	t = 10ms Sinusoidal half wave, Initial $T_J = T_J$ max.
I^2t Maximum I^2t for fusing	155	kA ² s	t = 10ms
$V_{T(TO)}$ Threshold voltage	0.98	V	$T_J = T_J$ max.
r_t On state slope resistance	0.95	mΩ	$T_J = T_J$ max.
V_{TM} Max. on state voltage	1.90	V	$I_{pk} = 785A$, $T_J = 125^\circ C$, $t_p = 10ms$ sine pulse
I_H Maximum holding current	600	mA	$T_J = 25^\circ C$, anode supply 12V resistive load
I_L Latching current	1000		

SWITCHING

Parameter	255RK	Units	Conditions
di/dt Max. non-repetitive rate of rise of turned-on current	100	A/μs	Gate drive 20V, 20Ω, $t_r \leq 1 \mu s$ $T_J = 125^\circ C$, anode voltage $\leq 80\% V_{DRM}$
t_d Typical delay time	1.0	μs	Gate current 1A, $di_g/dt = 1A/\mu s$ $V_d = 0.67\% V_{DRM}$, $T_J = 25^\circ C$
t_q Typical turn-off time	100		$I_{TM} = 550A$, $T_J = 125^\circ C$, $di/dt = 40A/\mu s$, $V_R = 50V$ $dv/dt = 20V/\mu s$, Gate 0V 100Ω, $t_p = 500\mu s$

SILICON CONTROLLED RECTIFIERS

255RK SERIES

BLOCKING

	Parameter	255RK	Units	Conditions
dv/dt	Maximum critical rate of rise of off-state voltage	500	V/ μ s	$T_J = 125^\circ\text{C}$, linear to 80% rated V_{DRM}
I_{RRM} I_{DRM}	Max. peak reverse and off-state leakage current	50	mA	$T_J = 125^\circ\text{C}$, rated V_{DRM} / V_{RRM} applied

TRIGGERING

	Parameter	255RK		Units	Conditions
P_{GM}	Maximum peak gate power	10.0		W	$T_J = 125^\circ\text{C}$, $t_p \leq 5\text{ms}$
$P_{\text{G(AV)}}$	Maximum average gate power	2.0			$T_J = 125^\circ\text{C}$, $f = 50\text{Hz}$, $d\% = 50$
I_{GM}	Max. peak positive gate current	3.0		A	$T_J = 125^\circ\text{C}$, $t_p \leq 5\text{ms}$
$+V_{\text{GM}}$	Max. peak positive gate voltage	20		V	$T_J = 125^\circ\text{C}$, $t_p \leq 5\text{ms}$
$-V_{\text{GM}}$	Max. peak negative gate voltage	5.0			
I_{GT}	DC gate current required to trigger	TYP.	MAX.	mA	$T_J = 25^\circ\text{C}$ Max. required gate trigger / current / voltage are the lowest value which will trigger all units 12V anode-to-cathode applied.
		100	200		
V_{GT}	DC gate voltage required to trigger	1.8	3.0	V	$T_J = 25^\circ\text{C}$
I_{GD}	DC gate current not to trigger	10		mA	$T_J = 125^\circ\text{C}$ Max. gate current / voltage not to trigger is the max. value which will not trigger any unit with rated V_{DRM} anode-to-cathode applied.
V_{GD}	DC gate voltage not to trigger	0.25		V	

THERMAL AND MECHANICAL SPECIFICATION

	Parameter	255RK	Units	Conditions
T_J	Max. operating temperature range	-40 to 125	$^\circ\text{C}$	
T_{stg}	Max. storage temperature range	-40 to 150		
R_{thJC}	Max. thermal resistance, junction to case	0.105	K/W	DC operation
R_{thCS}	Max. thermal resistance, case to heat sink	0.03		Mounting surface, smooth, flat and greased
T	Mounting torque, $\pm 10\%$	48.5	Nm	Non lubricated threads
wt	Approximate weight	535	gm	
	Case style	To - 209AE (TO-118)		See outline

SILICON CONTROLLED RECTIFIERS

ORDER INFORMATION TABLE

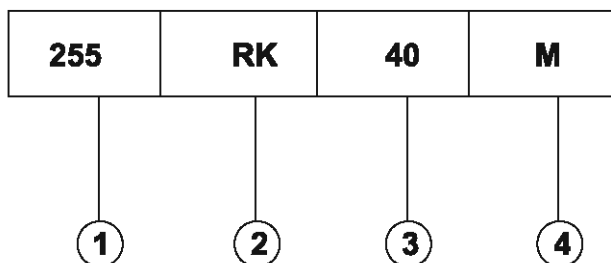

- ① - Current Code
 - ② - RK - Essential part number
 - ③ - Voltage Rating (See table)
 - ④ - None - Stud 3/4" 16UNF 2A Threading
M - Stud M20 x 1.5P Metric Threading
-

SILICON CONTROLLED RECTIFIERS

255RK SERIES

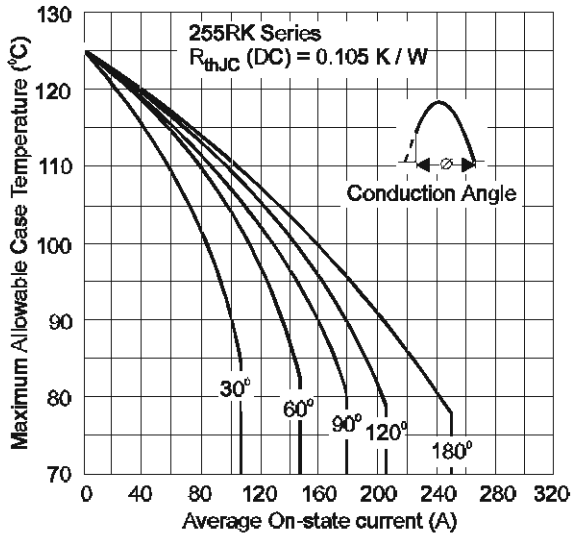

Fig. 1 - Current Ratings Characteristics

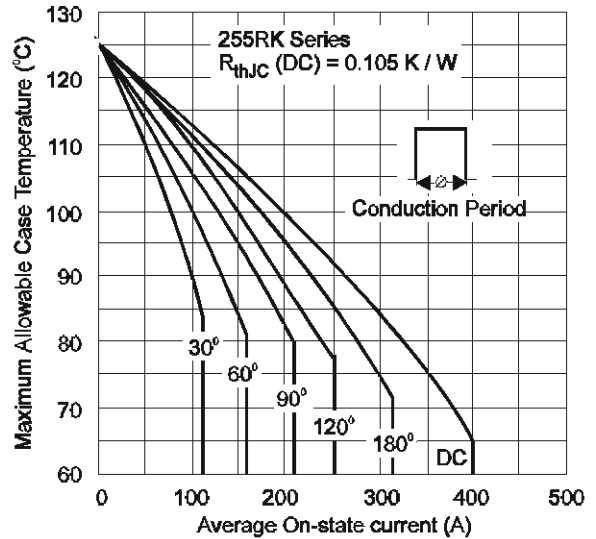

Fig. 2 - Current Ratings Characteristics

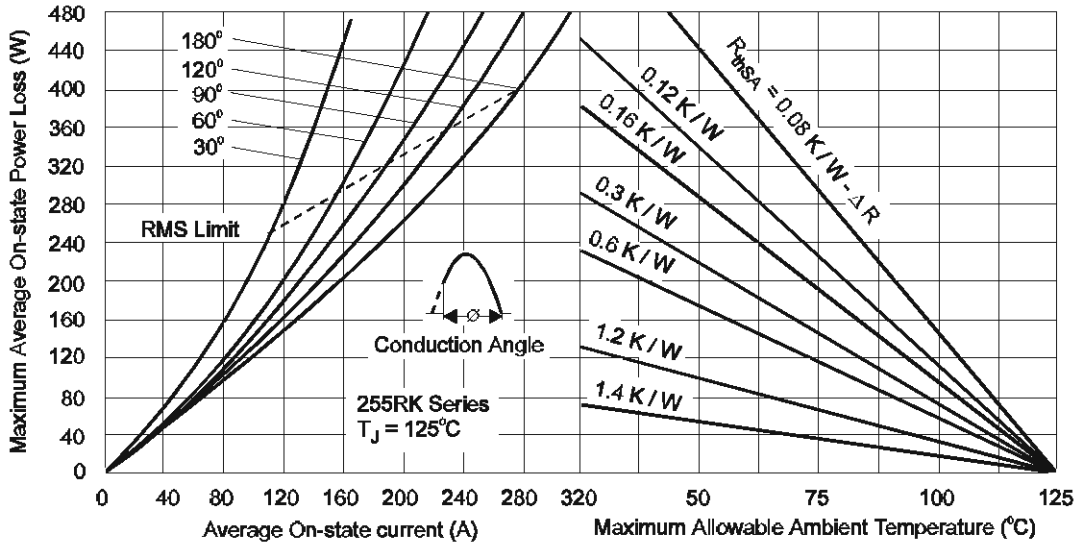

Fig. 3 - On-state Power Loss Characteristics

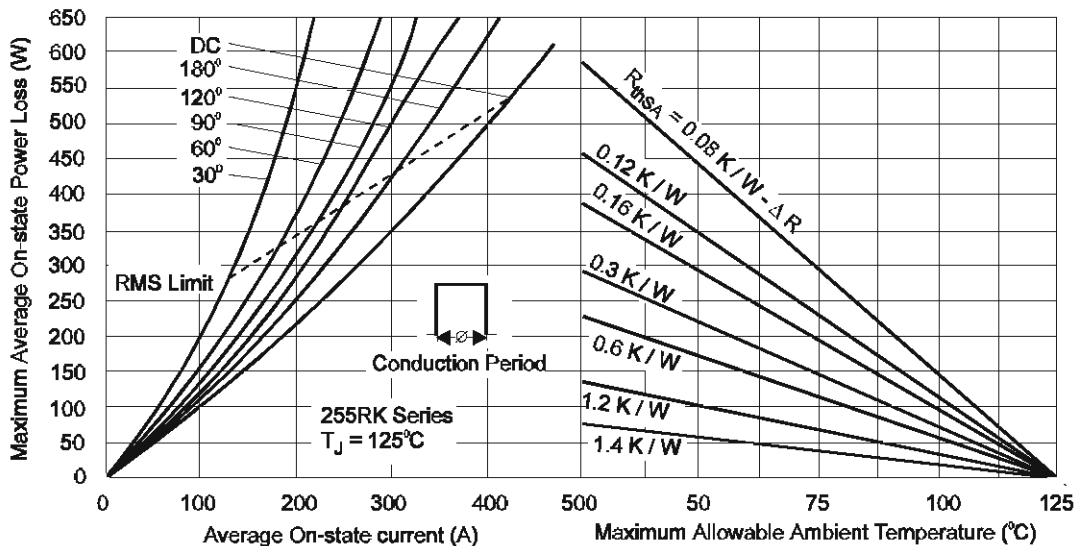

Fig. 4 - On-state Power Loss Characteristics

SILICON CONTROLLED RECTIFIERS

255RK SERIES

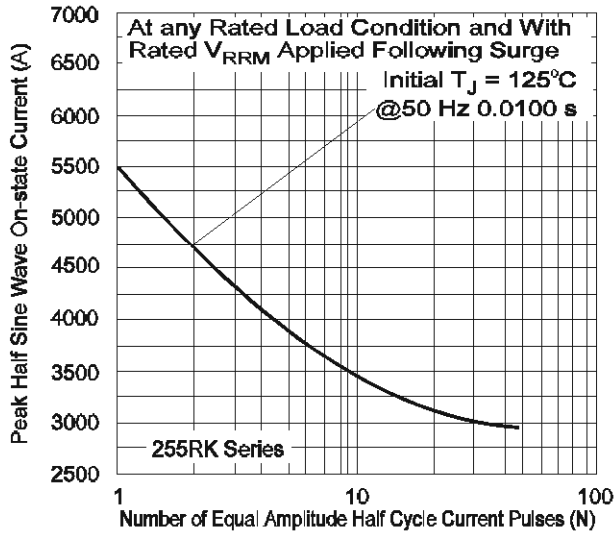

Fig. 5 - Maximum Non-Repetitive Surge Current

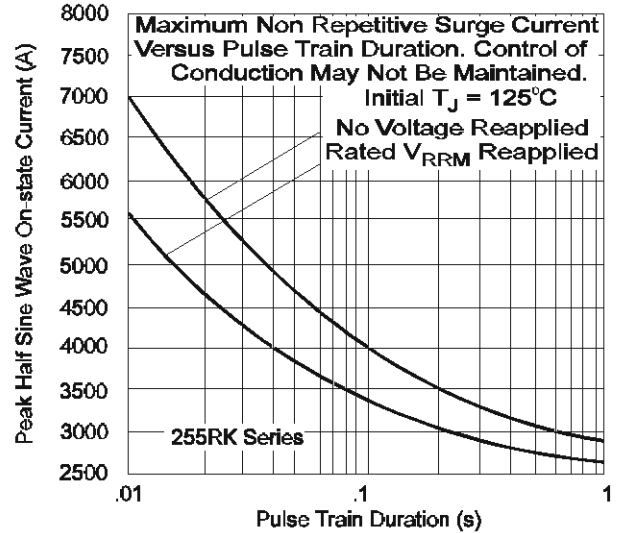

Fig. 6 - Maximum Non-Repetitive Surge Current

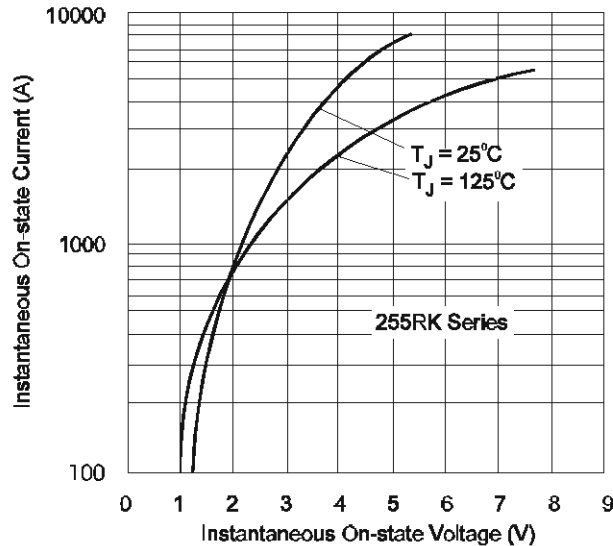

Fig. 7 - On-state Voltage Drop Characteristics

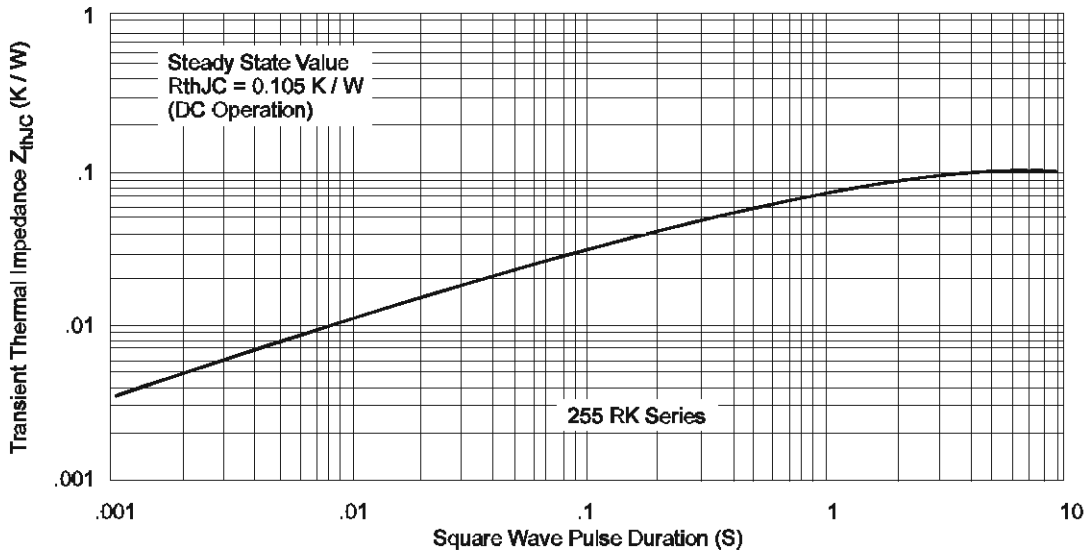

Fig. 8 - Thermal Impedance Z_{thJC} Characteristics

SILICON CONTROLLED RECTIFIERS

255RK SERIES

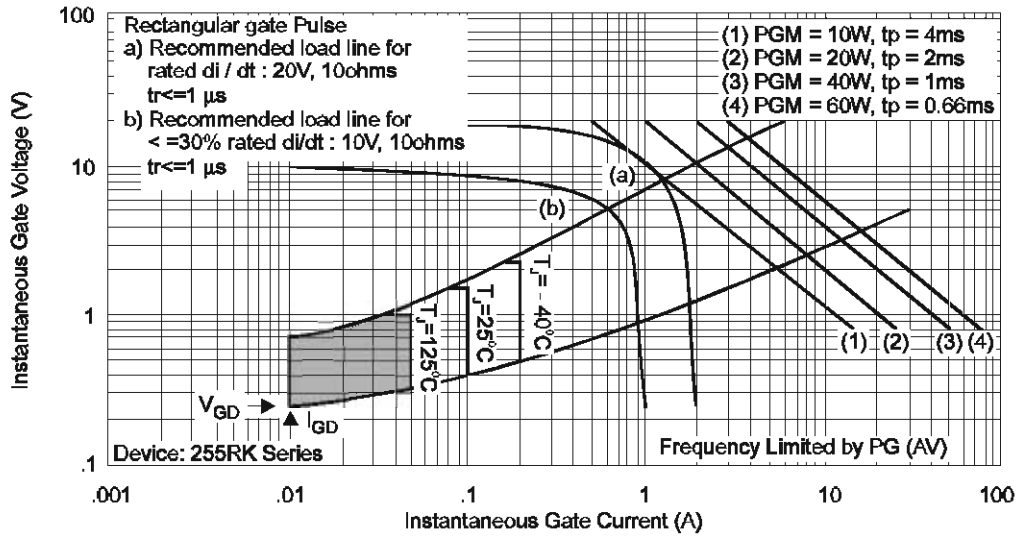

Fig. 9 - Gate Characteristics