

High Power Thyristor Hockey Puk Version E-PUK Series 600PE

Types: 600Pe 20 to 600PE 160

FEATURES

- ❖ Center amplifying gate.
- ❖ International standard case TO-200AB (E-PUK)
- ❖ High profile hockey - puk.

TYPICAL APPLICATIONS

- ❖ DC motor control (e.g. for machine tools).
- ❖ Controlled rectifiers (e.g. for battery charging, UPS).
- ❖ AC controllers (e.g. for temperature control, lights control).



MAJOR RATINGS & CHARACTERISTICS

Parameters	600PE	Units
$I_{T(AV)}$	650	A
@ T_{hs}	55	°C
$I_{T(RMS)}$	1230	A
@ T_{hs}	25	°C
I_{TSM}	9000	A
@ 50 Hz		
I^2t	405	KA ² s
@ 50 Hz		
V_{DRM} / V_{RRM}	200 to 1600	V
t_q	100	μs
typical		
T_J	-40 to 125	°C

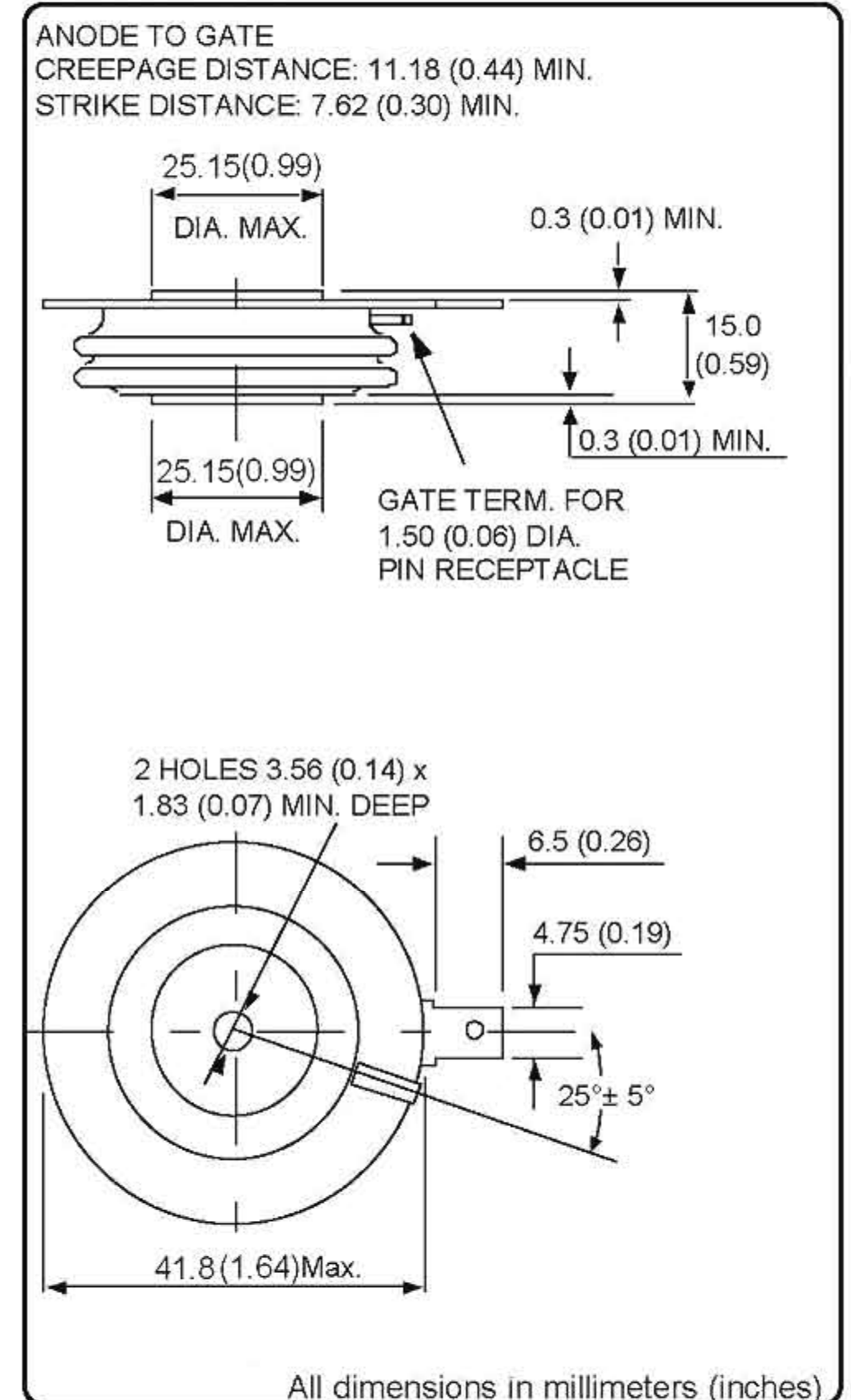

SILICON CONTROLLED RECTIFIERS

600PE

ELECTRICAL SPECIFICATION VOLTAGE RATINGS

Type Number	Voltage Code	V_{RRM} / V_{DRM} max. repetitive peak and off-state voltage V	V_{RSM} max. non-repetitive peak voltage V	I_{DRM} / I_{RRM} max. @ 125°C mA
600PE	20	200	300	50
	40	400	500	
	60	600	700	
	80	800	900	
	100	1000	1100	
	120	1200	1300	
	140	1400	1500	
	160	1600	1700	

ON-STATE CONDUCTION

Parameter	600PE	Units	Conditions	
$I_{T(AV)}$ Max. average on-state current @ heat sink temperature	650	A	180° conduction, half sine wave double side cooled	
	55	°C		
$I_{T(RMS)}$ Max. RMS on-state current	1230	A	@25°C heat sink temperature (double side cooled)	
I_{TSM} Max. peak one cycle non-repetitive surge current	9000		t = 10ms	Sinusoidal half Wave Initial $T_J = T_J$ max.
			t = 10ms	
I^2t Maximum I^2t for fusing	405	kA ² s	t = 10ms	
$V_{T(TO)}$ Threshold voltage	0.91	V	$T_J = T_J$ max.	
r_t On state slope resistance	0.78	mΩ	$T_J = T_J$ max.	
V_{TM} Max. on state voltage	1.90	V	$I_{pk} = 1730A$, $T_J = 125^\circ C$, $t_p = 10ms$ sine pulse	
I_H Maximum holding current	600	mA	$T_J = 25^\circ C$, anode supply 12V resistive load	
I_L Latching current	1000			

SWITCHING

Parameter	600PE	Units	Conditions
di/dt Max. non-repetitive rate of rise of turned-on current	100	A/μs	Gate drive 20V, 20Ω, $t_r \leq 1 \mu s$ $T_J = 125^\circ C$, anode voltage $\leq 80\% V_{DRM}$
t_d Typical delay time	1.0	μs	Gate current 1A, $di_g/dt = 1A/\mu s$ $V_d = 0.67\% V_{DRM}$, $T_J = 25^\circ C$
t_q Typical turn-off time	100		$I_{TM} = 550A$, $T_J = 125^\circ C$, $di/dt = 40A/\mu s$, $V_R = 50V$ $dv/dt = 20V/\mu s$, Gate 0V 100Ω, $t_p = 500\mu s$

SILICON CONTROLLED RECTIFIERS

600PE

BLOCKING

	Parameter	600PE	Units	Conditions
dv/dt	Maximum critical rate of rise of off-state voltage	500	V/ μ s	$T_J = 125^\circ\text{C}$, linear to 80% rated V_{DRM}
I_{RRM} I_{DRM}	Max. peak reverse and off-state leakage current	50	mA	$T_J = 125^\circ\text{C}$, rated $V_{\text{DRM}}/V_{\text{RRM}}$ applied

TRIGGERING

	Parameter	600PE		Units	Conditions
P_{GM}	Maximum peak gate power	10.0		W	$T_J = 125^\circ\text{C}$, $t_p \leq 5\text{ms}$
$P_{\text{G(AV)}}$	Maximum average gate power	2.0			$T_J = 125^\circ\text{C}$, $f = 50\text{Hz}$, $d\% = 50$
I_{GM}	Max. peak positive gate current	3.0		A	$T_J = 125^\circ\text{C}$, $t_p \leq 5\text{ms}$
$+V_{\text{GM}}$	Max. peak positive gate voltage	20		V	$T_J = 125^\circ\text{C}$, $t_p \leq 5\text{ms}$
$-V_{\text{GM}}$	Max. peak negative gate voltage	5.0			
I_{GT}	DC gate current required to trigger	TYP.	MAX.	mA	$T_J = 25^\circ\text{C}$ Max. required gate trigger/current / voltage are the lowest value which will trigger all units 12V anode-to-cathode applied.
		100	200		
V_{GT}	DC gate voltage required to trigger	1.8	3.0	V	$T_J = 25^\circ\text{C}$
I_{GD}	DC gate current not to trigger	10		mA	$T_J = 125^\circ\text{C}$ Max. gate current / voltage not to trigger is the max. value which will not trigger any unit with rated V_{DRM} anode-to-cathode applied.
V_{GD}	DC gate voltage not to trigger	0.25		V	

THERMAL AND MECHANICAL SPECIFICATION

	Parameter	600PE	Units	Conditions
T_J	Max. operating temperature range	-40 to 125	$^\circ\text{C}$	
T_{stg}	Max. storage temperature range	-40 to 150		
$R_{\text{thJ-hs}}$	Max. thermal resistance, junction to heat sink	0.05	K/W	DC operation double side cooled
F	Mounting force, $\pm 10\%$	9800	N	
wt	Approximate weight	83	g	
	Case style	To - 200AB		See outline

SILICON CONTROLLED RECTIFIERS

600 PE

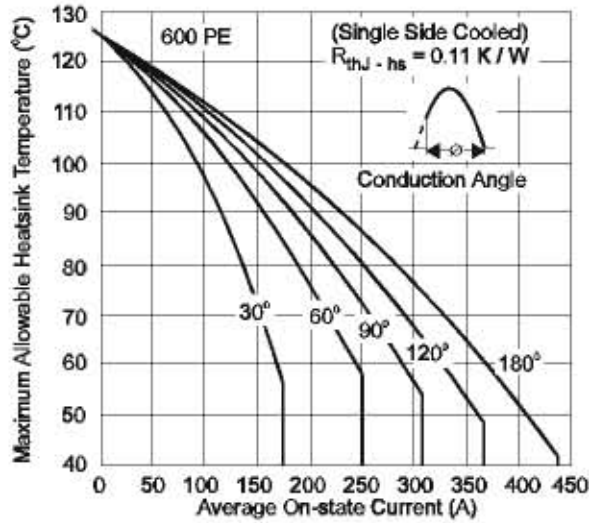

Fig. 1 - Current Ratings Characteristics

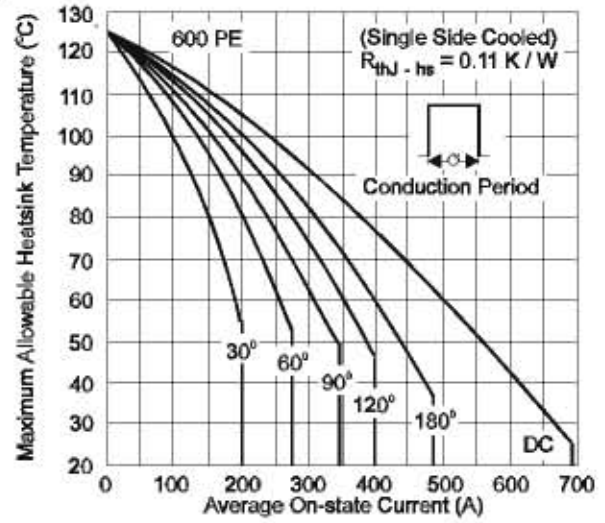

Fig. 2 - Current Ratings Characteristics

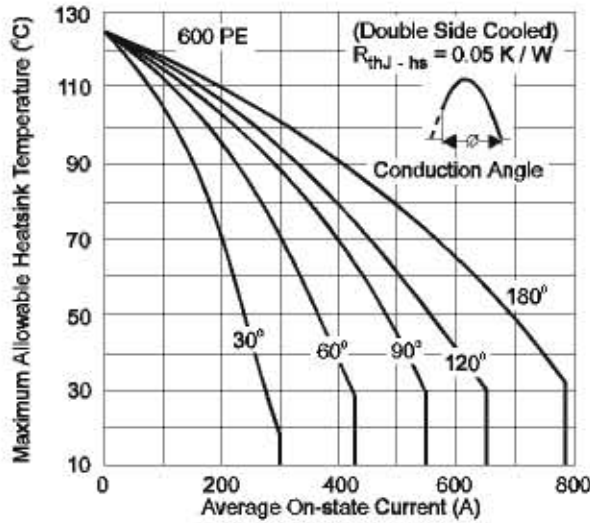

Fig. 3 - Current Ratings Characteristics

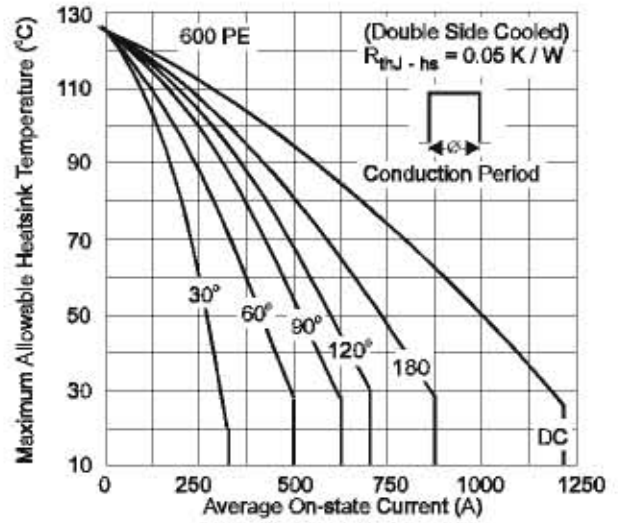

Fig. 4 - Current Ratings Characteristics

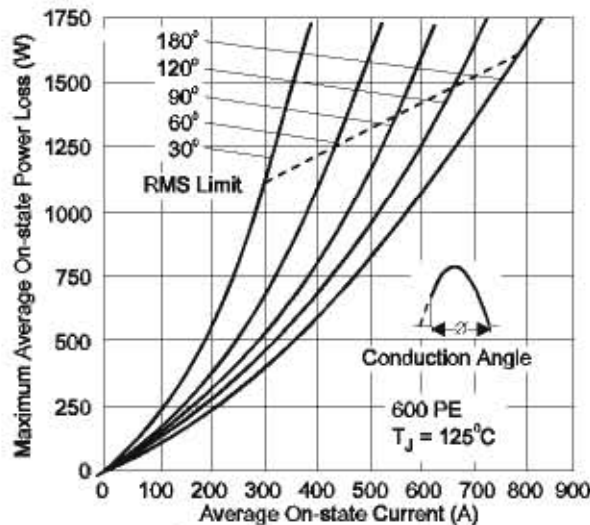

Fig. 5 - On-state Power Loss Characteristics

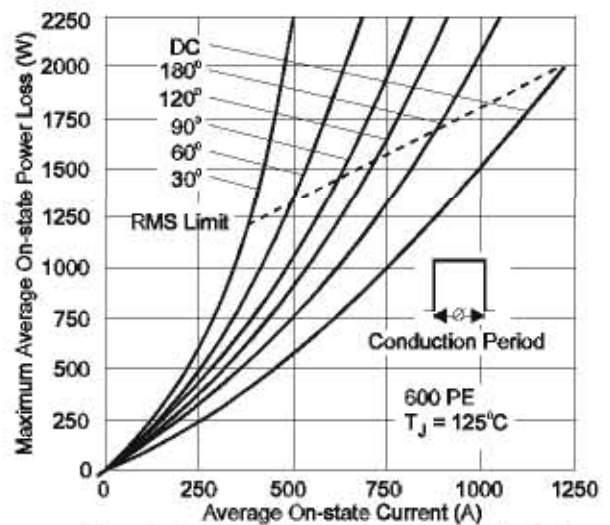

Fig. 6 - On-state Power Loss Characteristics

SILICON CONTROLLED RECTIFIERS

600 PE *

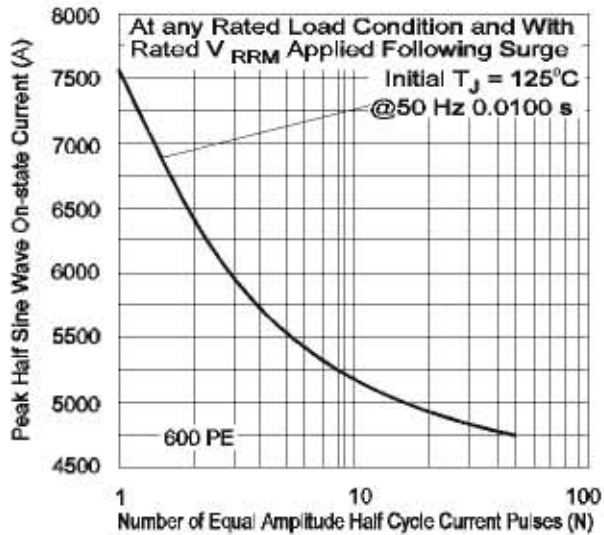

Fig. 7 - Maximum Non-Repetitive Surge Current

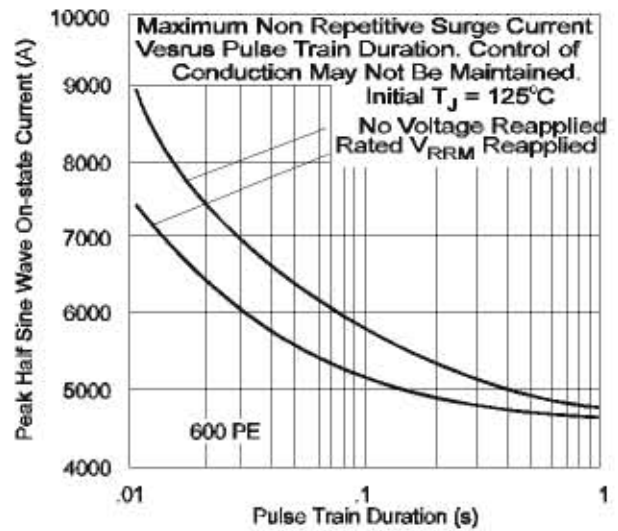

Fig. 8 - Maximum Non-Repetitive Surge Current

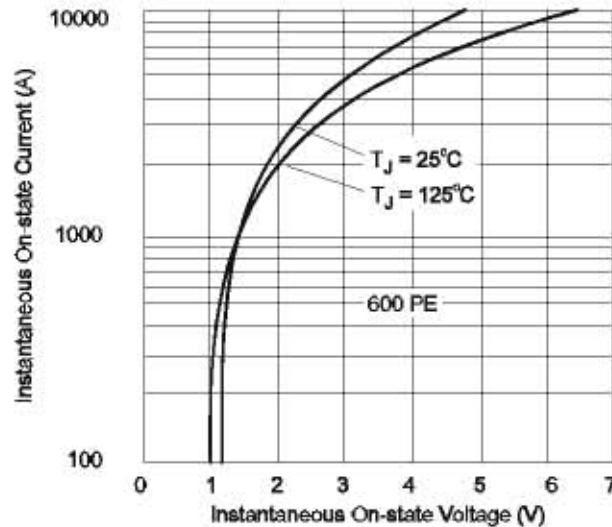

Fig. 9 - On-state Voltage Drop Characteristics

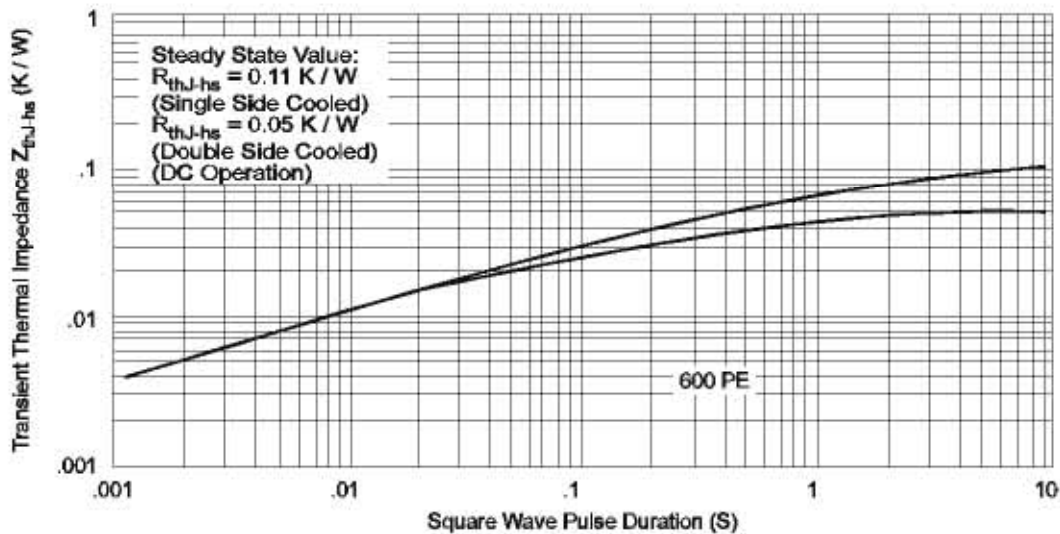

Fig. 10 - Thermal Impedance Z_{thJ-hs} Characteristics

SILICON CONTROLLED RECTIFIERS

600 PE

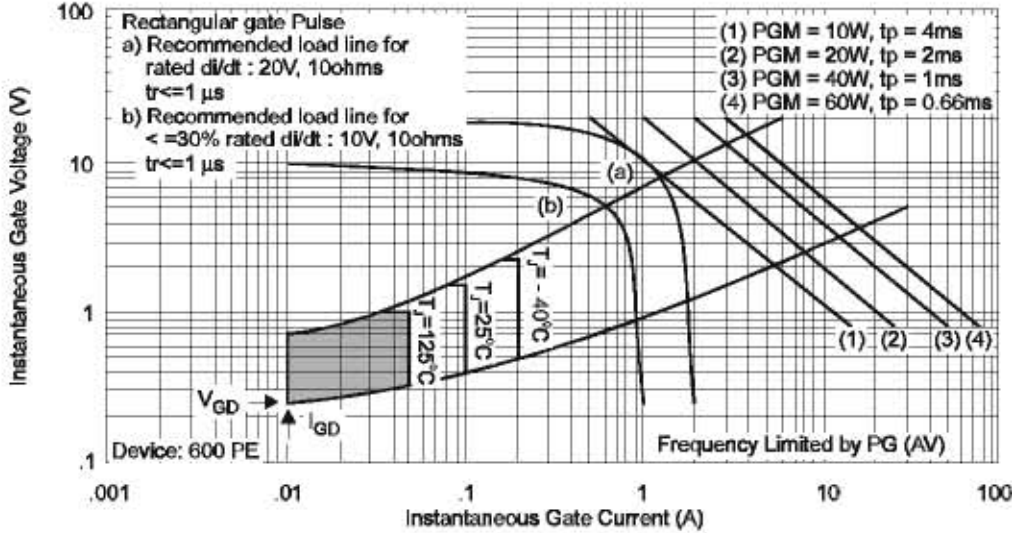

Fig.11 - Gate Characteristics